

K1 SE

USER MANUAL

K1 SE 3D Printer

V 1.0_EN

To Our Dear Users

Thank you for choosing Creality. For your convenience, please read through this User Manual before you start and follow the instructions provided carefully.

Creality is always ready to provide you with high-quality services. If you encounter any issues or have any questions when using our products, please use the contact information at the end of this manual to contact us. To further improve your user experience, you can find more about our devices via the following methods:

User manual: You can find instructions and videos in the USB flash disk provided with the printer.

You can also visit our official website (<https://www.creality.com>) to find information regarding software, hardware, contact information, device instructions, device warranty information, and more.

Firmware Upgrade

1. You can upgrade the firmware directly through the device screen;
2. You can upgrade the firmware via the Creality Cloud OTA;
3. Please visit the official website <https://www.creality.com>, click on “Support → Download Center” , select the corresponding model to download the required firmware, (Or click on “Creality Cloud → Downloads → Firmware”) , after installation is complete, you can use it.

Product Operation and After-Sales Service Information

1. You can log in to the Creality Official Wiki (<https://wiki.creality.com>) to explore more detailed after-sales service tutorials.
2. Or contact our after-sales service center at +86 755 3396 5666, or send e-mail to cs@creality.com.



Creality Wiki

1. Do not use the printer in any way other than described herein in order to avoid personal injury or property damage;
2. Do not place the printer near any heat source or flammable or explosive objects. We suggest placing it in a well-ventilated, cool and dustless environment;
3. Do not expose the printer to a violent vibration or any other unstable environment, as this may cause poor print quality;
4. Please use recommended filaments to avoid clogging of the extrusion head and causing damage to the machine;
5. Do not use the power cable of other products during installation. Always use a grounded three-prong power outlet, which accompanies the printer;
6. Do not touch the nozzle and the heated bed during operation to avoid burns or personal injury;
7. Do not wear gloves or wraps while operating the machine to prevent entrapment of movable parts that could cause crushing and cutting injuries to bodily parts;
8. Use the provided tools to clean the filament from the extruder in time taking advantage of the residual temperature after printing. Do not touch the extruder directly when cleaning, otherwise it may cause burns;
9. Clean the printer frequently. Clean the printer body with a dry cloth regularly after powering off the printer, wipe away dust, bonded print filament and foreign objects ;
10. Children under 10 years old should not use the printer without supervision, otherwise it may cause personal injury;
11. Users should comply with the laws and regulations of the corresponding countries and regions where the equipment is located (used), abide by professional ethics, pay attention to safety obligations, and strictly prohibit the use of our products or equipment for any illegal purposes; Creality will not be responsible for any violators' legal liability under any circumstance;
12. Tip: Do not plug in or unplug wires on a charged basis.



1. About the Device	01-03
1.1 About the Printer	01-01
1.2 Device Specifications	02-02
1.3 Packing List	03-03
2. Unboxing	04-06
2.1 Install the Product	04-05
2.2 Power-on guide	06-06
3. About the User Interface	07-09
3.1 Main、Prepare	07-07
3.2 Files	08-08
3.3 Tune、Support	09-09
4. First Printing	10-14
4.1 USB flash disk Printing	10-10
4.2 LAN Printing	11-12
4.3 Creality Cloud Printing	13-14
5. Functional Specification	15-15
5.1 Extrude、Filament Retreat	15-15
6. Tips and Routine Maintenance	16-19
6.1 Maintenance Items	16-16
6.2 Precautions for printing	17-19

1. About the Device

1.1 About the Printer

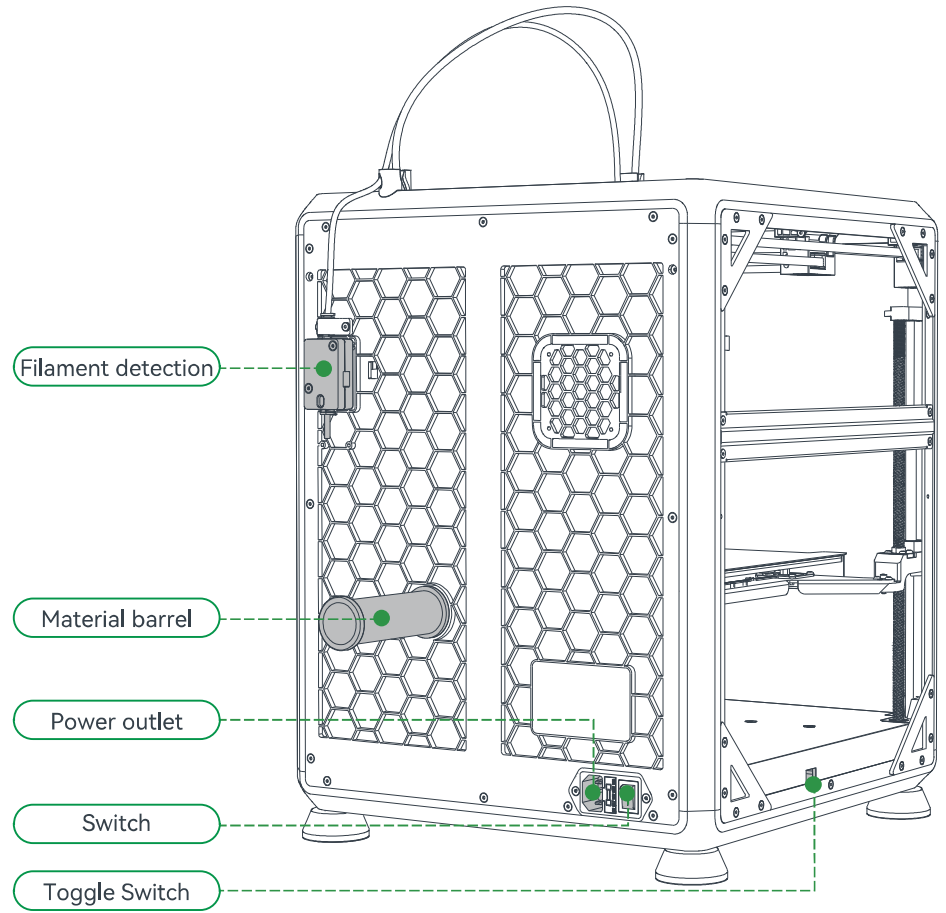
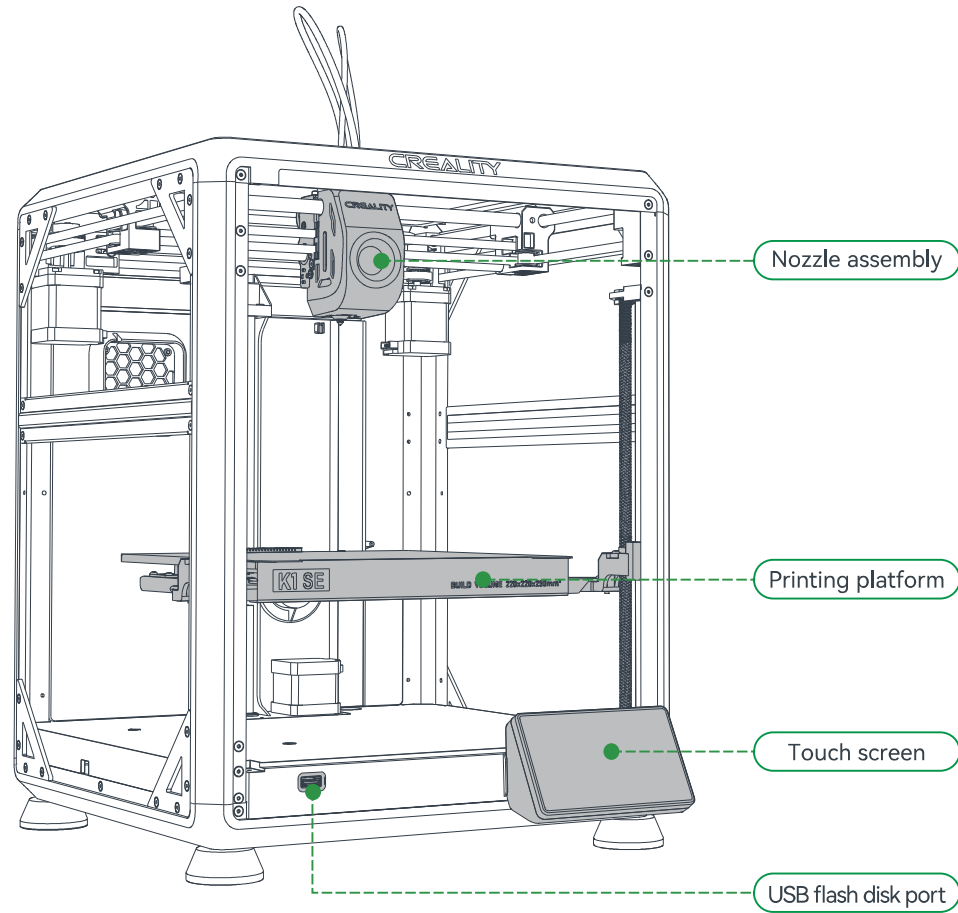

1. About the Device



1.2 Device Specifications

Basic Parameters	
Product Model	K1 SE
Dimensions	355*355*482mm
Machine Weight	10.24kg
Max. Build Dimensions	220*220*250mm
Print Technology	FDM
Rated Voltage	100-120V~/200-240V~, 50/60Hz
Rated Power	350W
Ambient temperature	10°C-35°C / 50°F-86°F
Extruder	Sprite Direct Drive
Supported Filament	Hyper PLA/PLA/TPU/PETG
Max. Heated Bed Temperature	100°C
Max. Nozzle Temperature	300°C
User Interface	4.3 inch touch screen
Print Interface	USB Flash Disk/LAN Printing/Crealty Cloud Printing
Power Loss Recovery	Yes
Filament Detection	Yes
Auto leveling	Yes







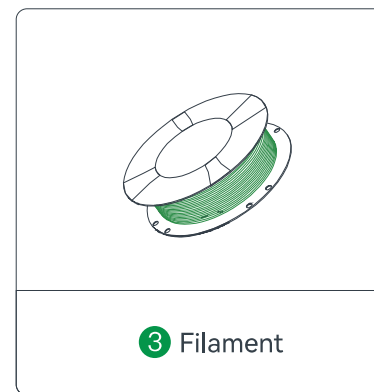
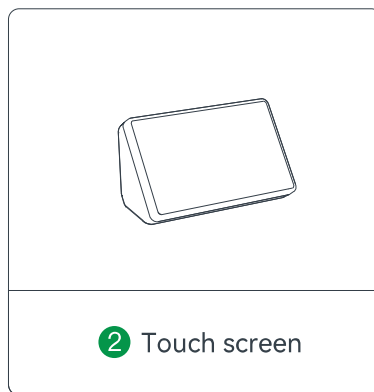
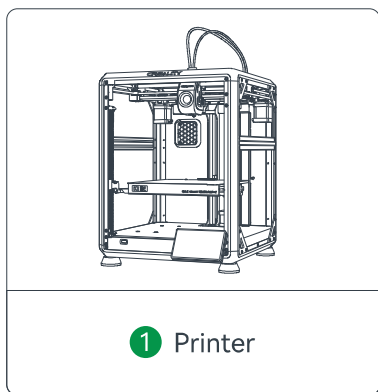

1. About the Device

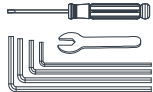

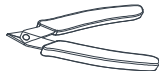
1.3 Packing List



Tool Box List

 <p>1 Wrench and Screwdriver ×1</p>	 <p>2 Blade ×1</p>	 <p>3 Material barrel ×1</p>	 <p>4 Cutting plier ×1</p>
 <p>5 1.2mm nozzle cleaner ×1</p>	 <p>6 USB flash disk ×1</p>	 <p>7 Power Cable ×1</p>	 <p>8 M6 socket spanner ×1</p>
 <p>9 Quick Guide ×1</p>	 <p>10 After-sales Services Card ×1</p>	<p>Tips: the above accessories are for reference only. Please refer to the physical accessories!</p>	

2. Unboxing

2.1 Install the Product

- 1 Take the touch screen out of the tool box and connect the touch screen to the flat cable extended from the base according to Figure A. Then snap the touch screen into the slot in the baseplate, as shown in Figure B. (The direction is as shown in the figure; otherwise, the screen interface may be damaged.)

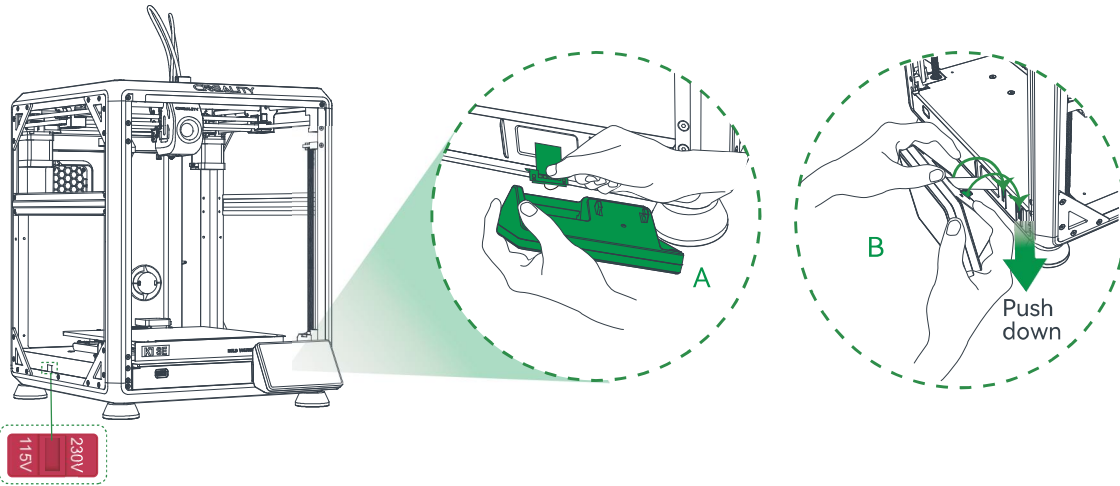

- ① Do not power up the machine while you are connecting or disconnecting the touch screen.
- ② The flexible flat cable of the base is pulled lightly and broken carefully.

⚠ Caution

- Please ensure the correct position for the power supply switch and mains before supply connection, in order to avoid damage to the device.
- If the mains between 100V and 120V, please select the 115V for the power supply switch with a straight screwdriver.
- If the mains between 200V and 240V, please select the 230V for the power supply switch (default is 230V) with a straight screwdriver.

- 2 Install the Teflon tube.

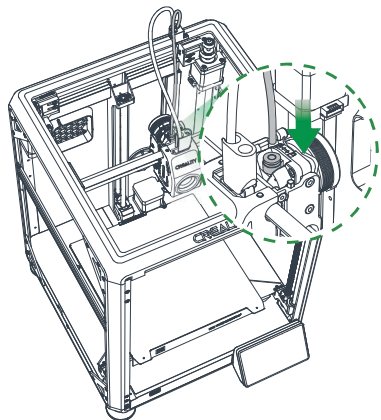

- 3 Install the material barrel.

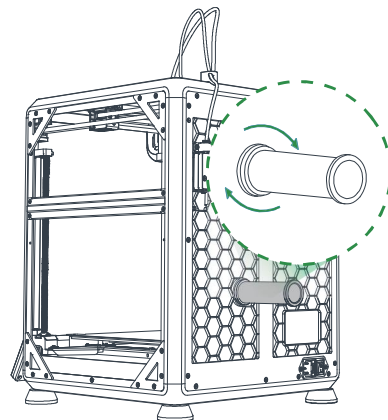

- 4 Connection and power on.

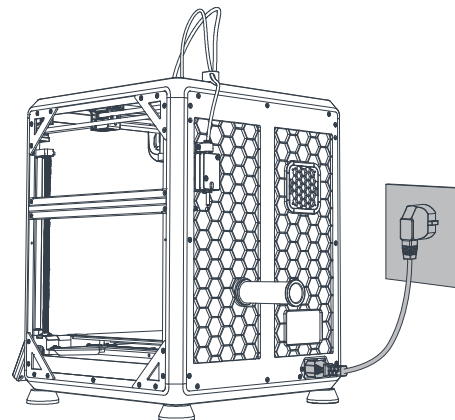

- 5 Load filaments. (Insert the filaments into the deepest part of Teflon tube until it cannot be moved.)

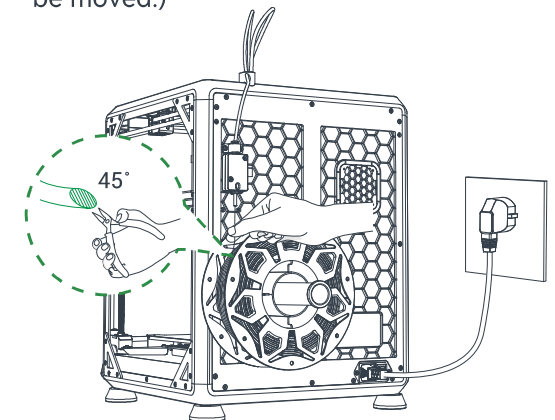

2. Unboxing

- ⑥ Select a language and click “Next”, Remove three screws a, b and c according to position indicated by the yellow arrow. click “OK” on the screen.

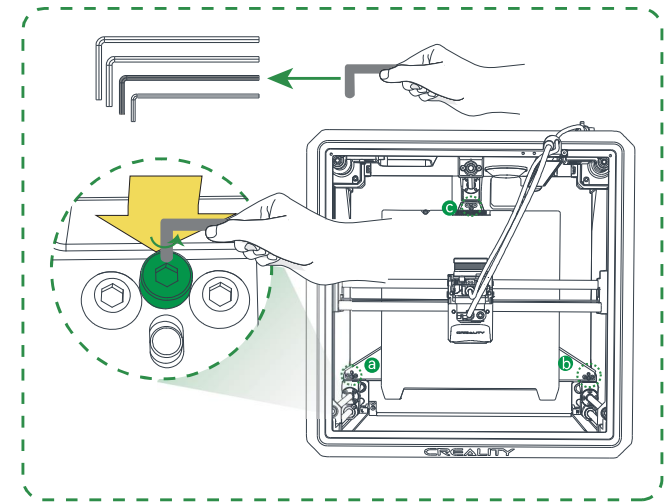
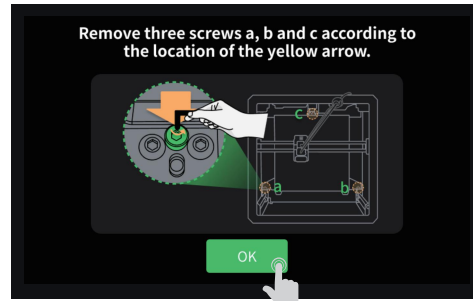
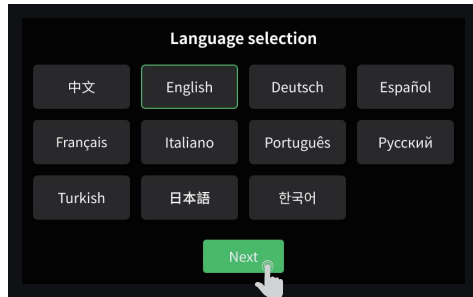

- ⑦ Keep the green cube in the figure clean of debris and then click “OK”.

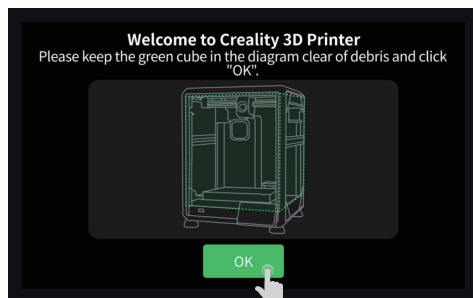

The current interface is for reference only. Due to the continuous upgrading of functions, it shall be subject to the latest software/firmware UI published on the official website.

2. Unboxing

2.2 Power-on guide

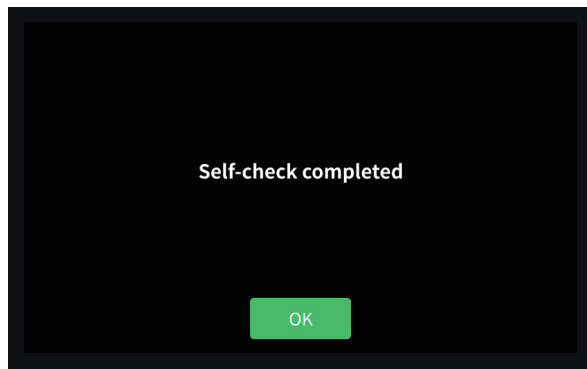
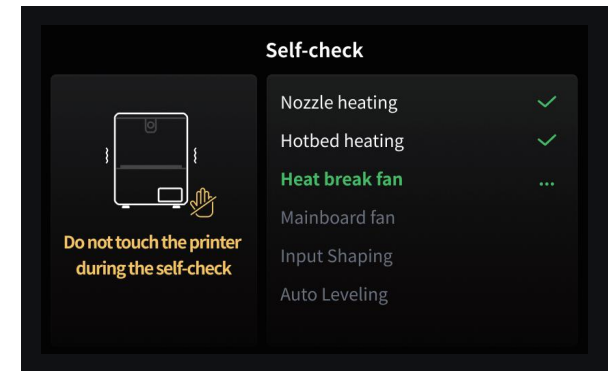
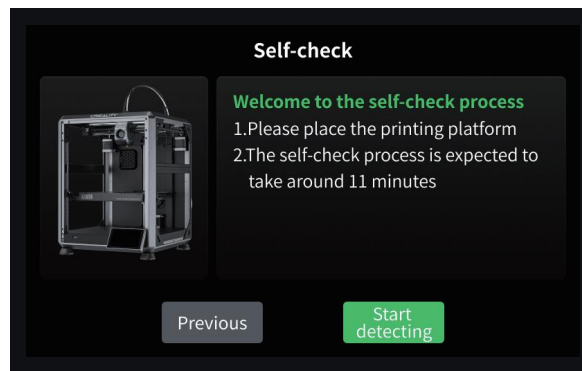
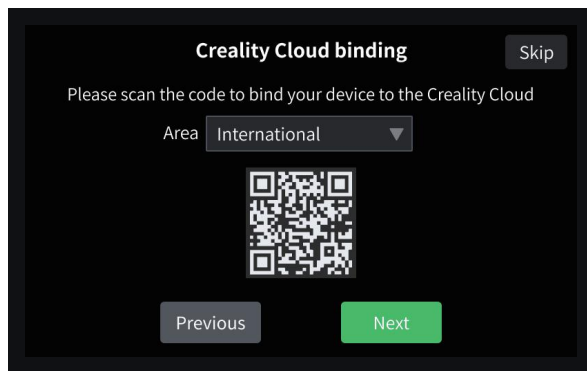
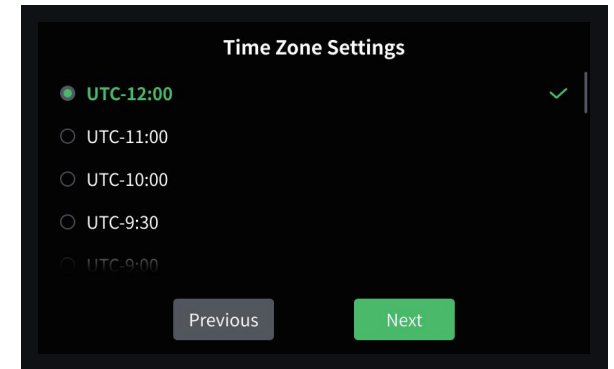
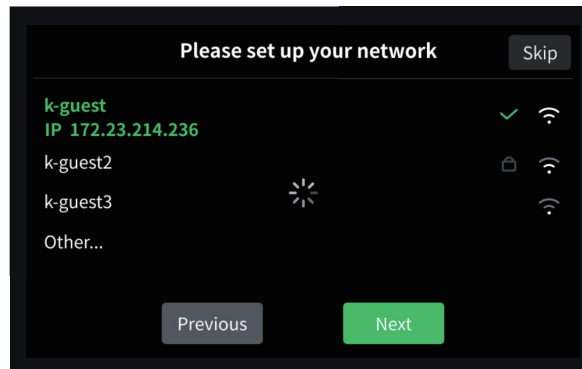
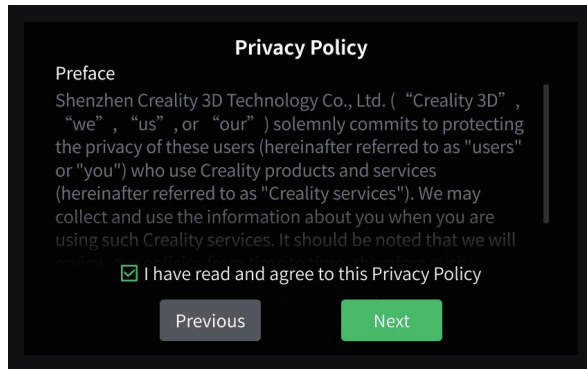

Reminder: When the printing time of the device exceeds 300 hours, or if the printing platform or nozzles have been replaced, the distance between the platform and nozzles may change that caused the first layer of the model may not stick firmly, resulting in printing failure. Please calibrate the platform regularly.



The current interface is for reference only. Due to the continuous upgrading of functions, it shall be subject to the latest software/firmware UI published on the official website.

3. About the User Interface

3.1 Main、Prepare

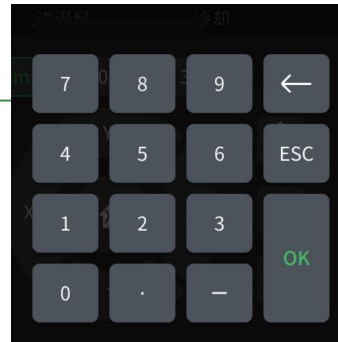
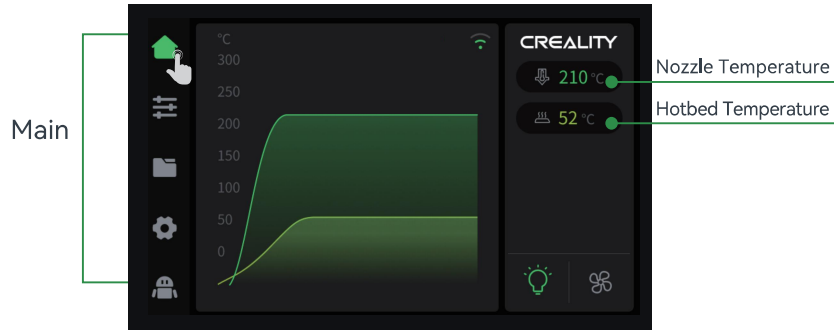

Parameters can be manually set

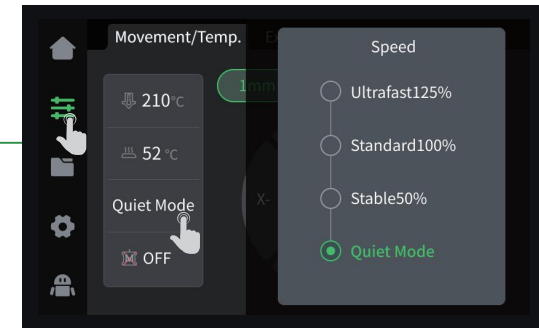

This screen allows you to reduce the machine's working volume by selecting the Mute Mode

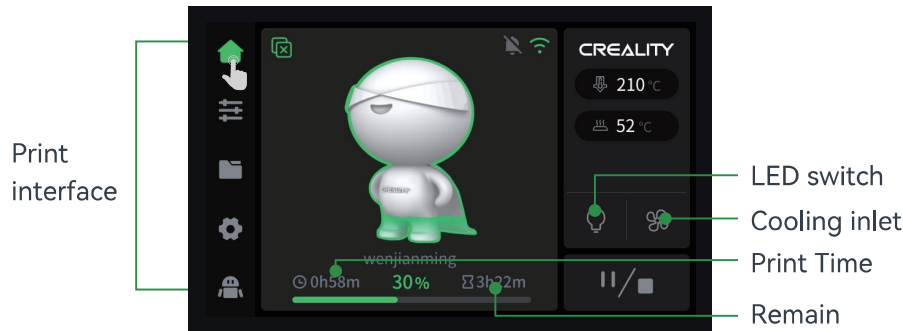

- LED switch
- Cooling inlet
- Print Time
- Remain



The current interface is for reference only. Due to the continuous upgrading of functions, it shall be subject to the latest software/firmware UI published on the official website.

Prepare

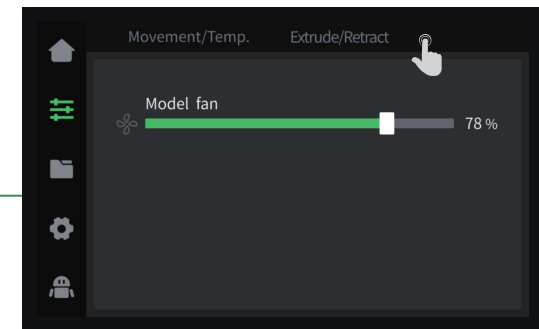
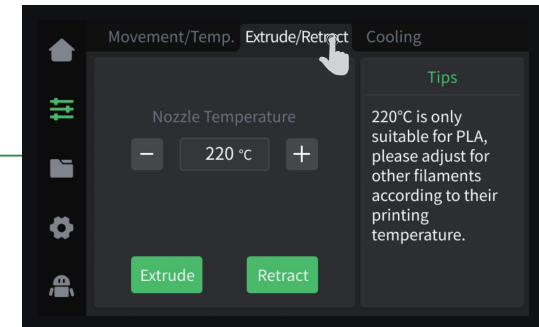

3. About the User Interface

3.2 Files



1 Local model

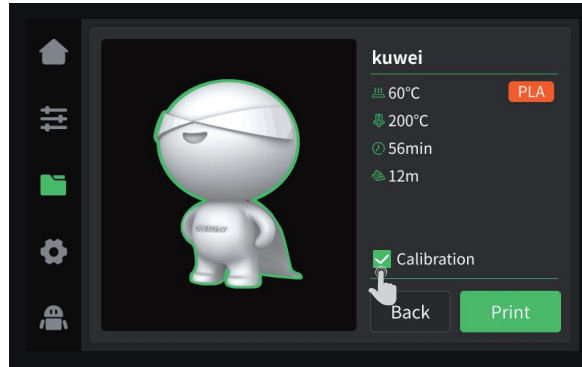

Tips: Choosing print calibration can improve print quality

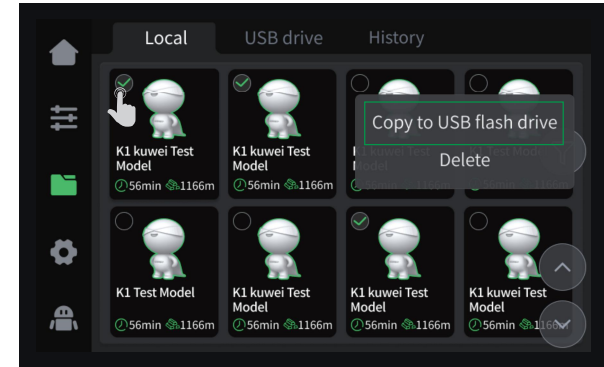

2 Press and hold on the model to multi-select and copy it to a USB flash drive

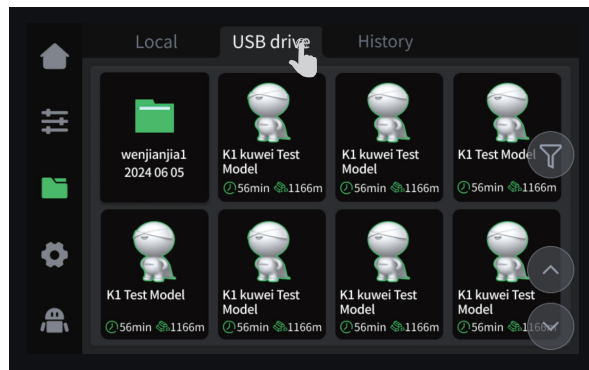

3 USB flash drive model

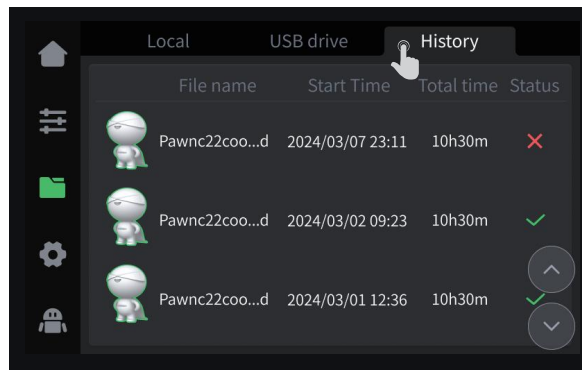

4 History

The current interface is for reference only. Due to the continuous upgrading of functions, it shall be subject to the latest software/ firmware UI published on the official website.

3. About the User Interface

3.3 Tune、Support

Tune

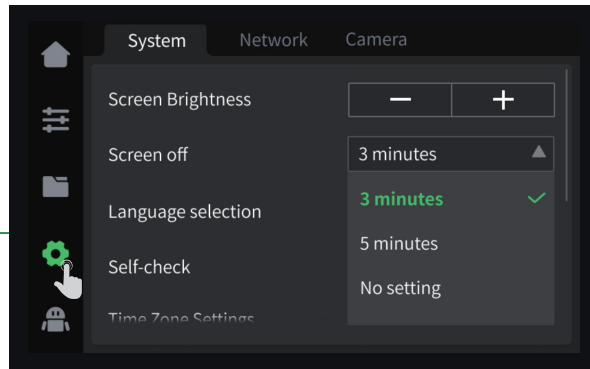

System

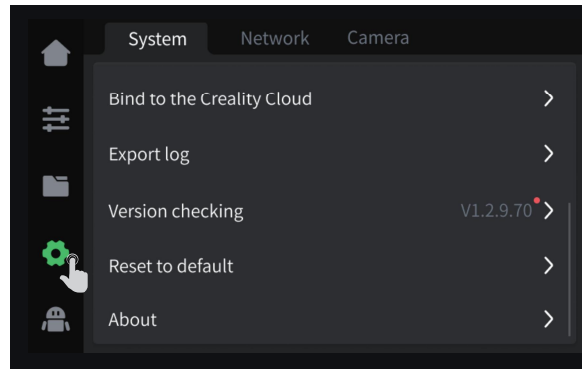

System

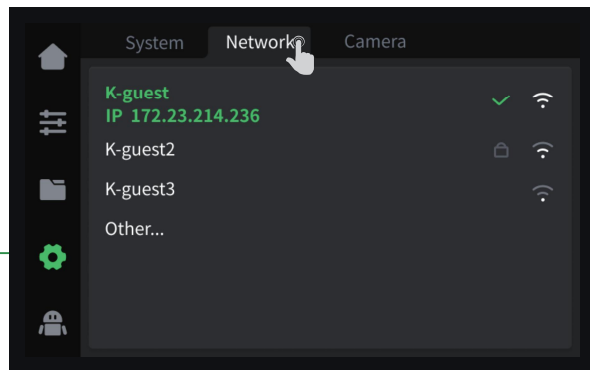

Network



The current interface is for reference only. Due to the continuous upgrading of functions, it shall be subject to the latest software/firmware UI published on the official website.

Support

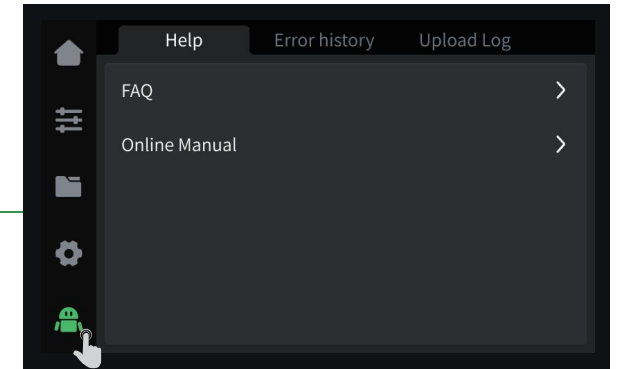

Help

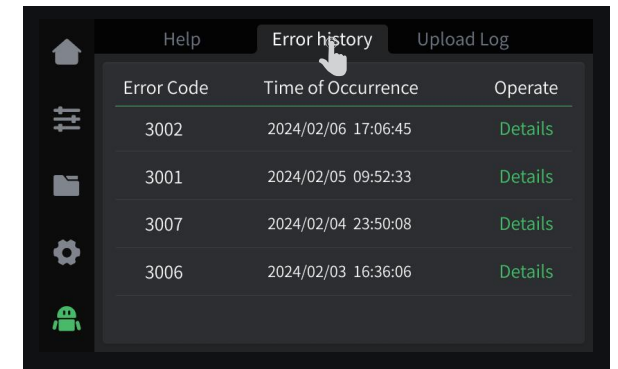

Error history

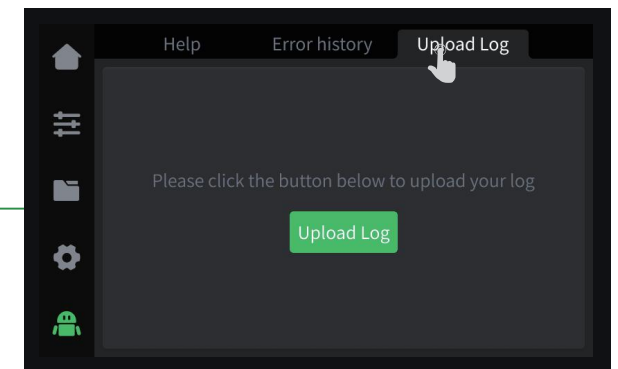

Upload Log

4. First Printing

4.1 USB flash disk Printing

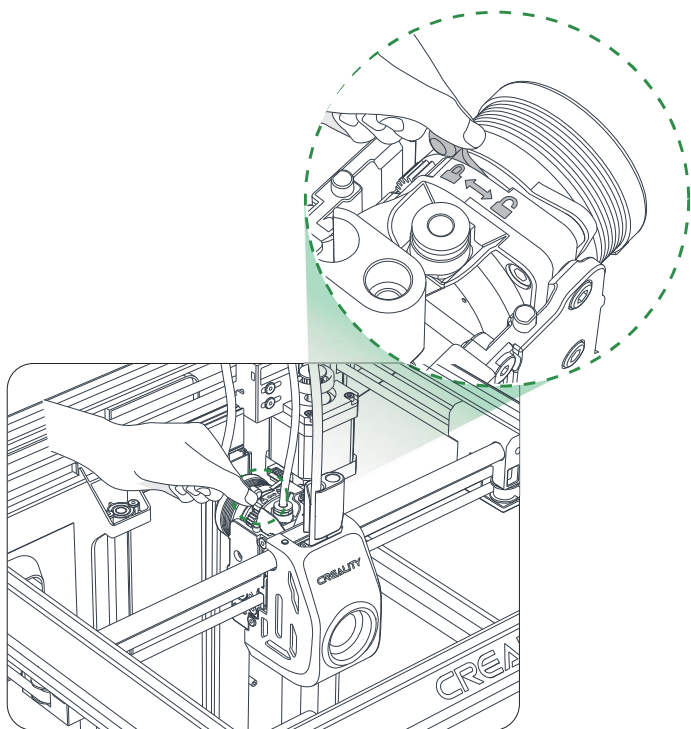

1 Insert the storage device

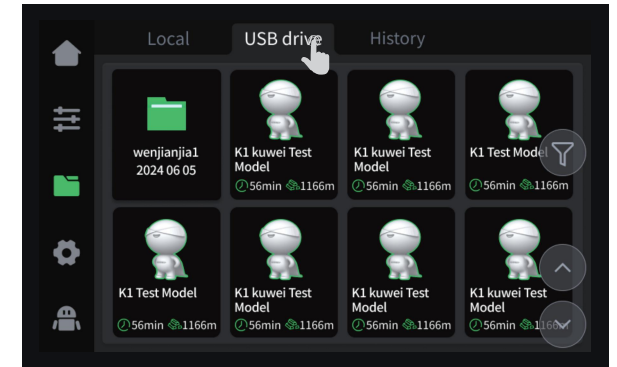
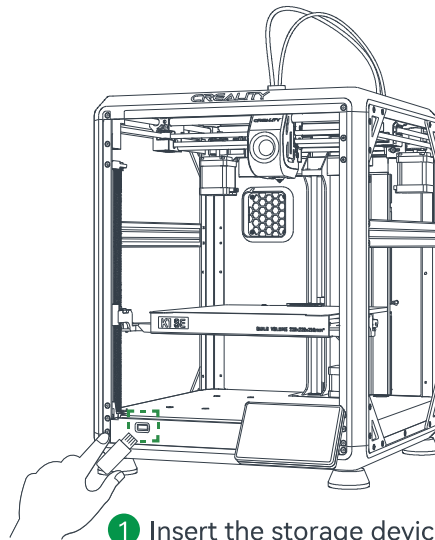

2 USB flash drive model

 Note: Keep the Extrusion switch lock before printing.

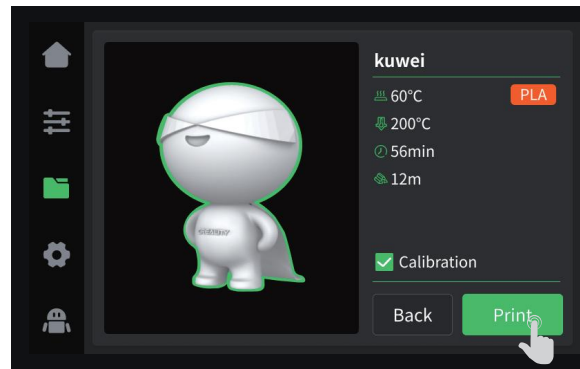

3 Select to print

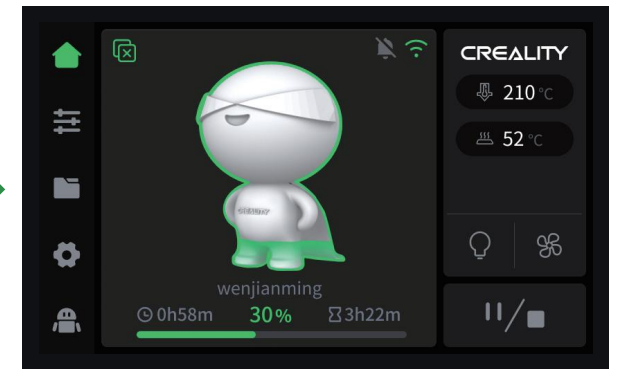

4 Printing

 The current interface is for reference only. Due to the continuous upgrading of functions, it shall be subject to the latest software/firmware UI published on the official website.

4. First Printing

4.2 LAN Printing



- 1 Download at (www.crealitycloud.com) or find the software on a USB flash drive and install it.

Tips: the computer must be in the same local area network as the printer

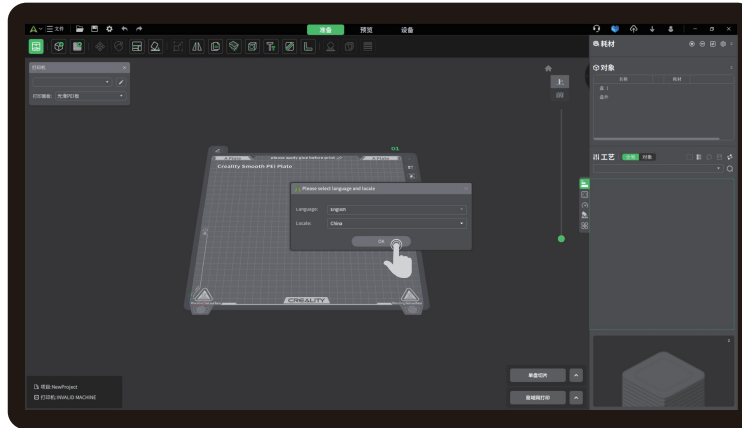

- 2 Choose a language and region

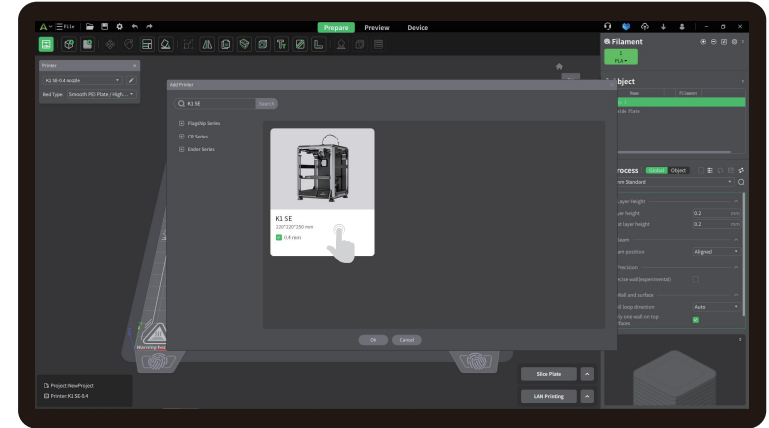

- 3 Choose a Printer

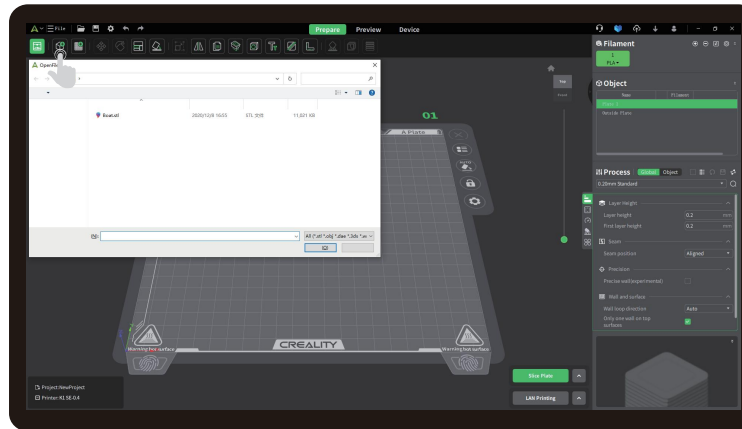

- 4 Import model files

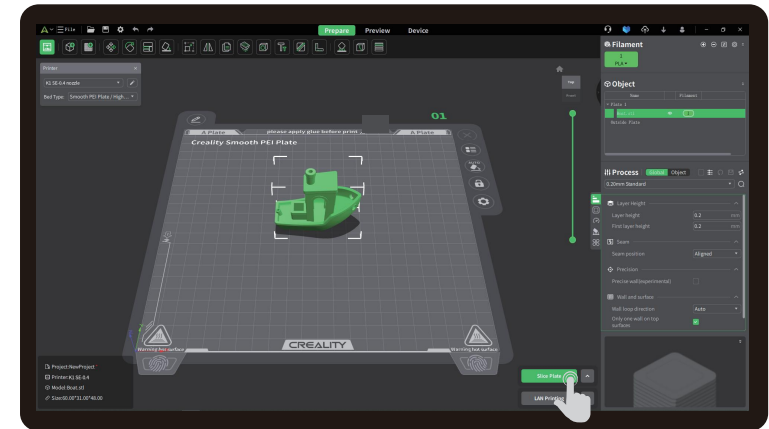

- 5 Open the model and click on “Slice Plate”

The current interface is for reference only. Due to the continuous upgrading of functions, it shall be subject to the latest software/firmware UI published on the official website.

4. First Printing

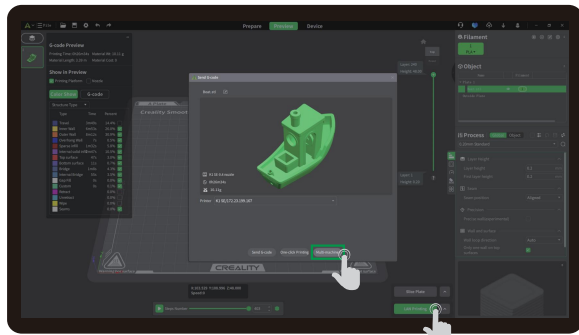

6 Select "LAN Printing" → "Multi-machine"

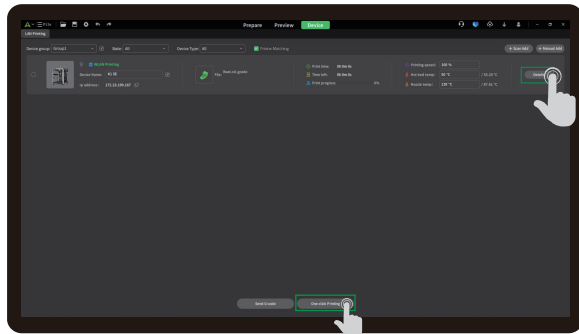

8 After selecting the device, click "One-click Printing" → "Details"

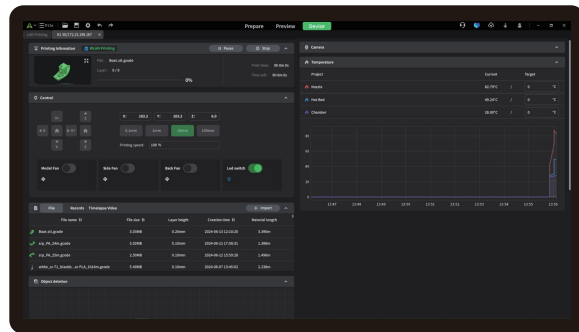

9 Device Details

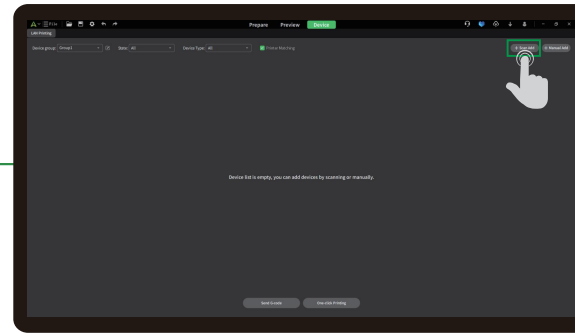

7 Add a device: a. Add by scanning → Select a device

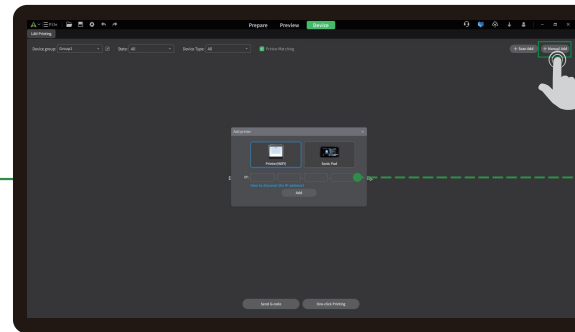
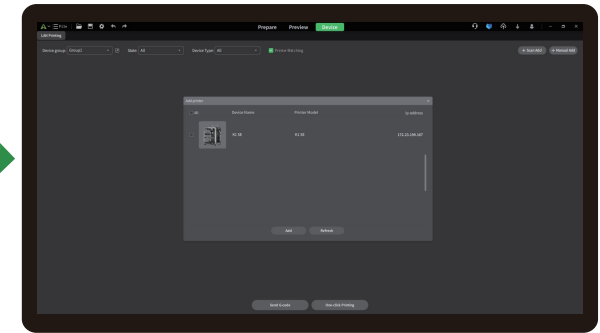

7 Add a device: b. Add a device by manually entering the IP address

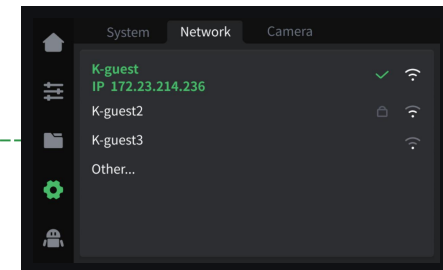

The current interface is for reference only. Due to the continuous upgrading of functions, it shall be subject to the latest software/firmware UI published on the official website.

4. First Printing

4.3 Creality Cloud printing

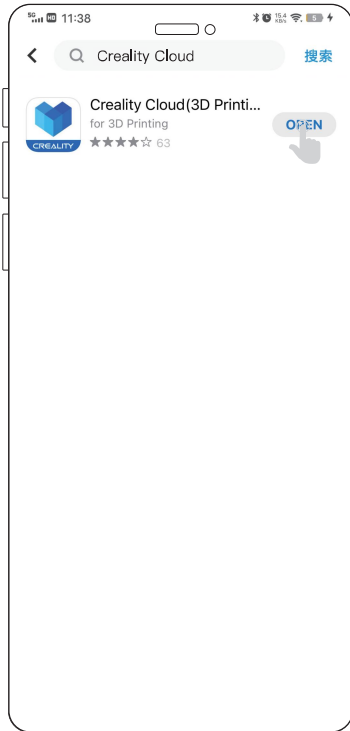

- 1 Search for “Creality Cloud” in the App Store, download and install it

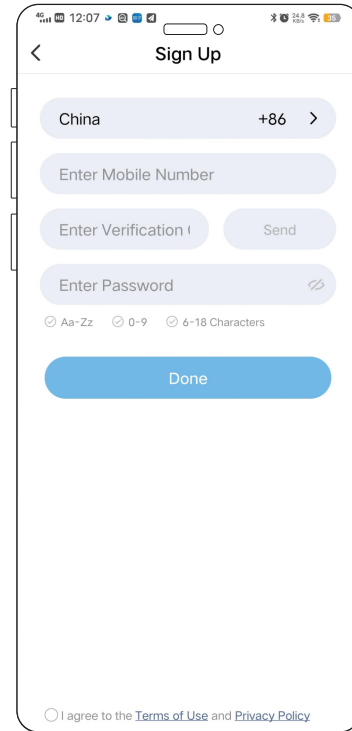

- 2 Sign up

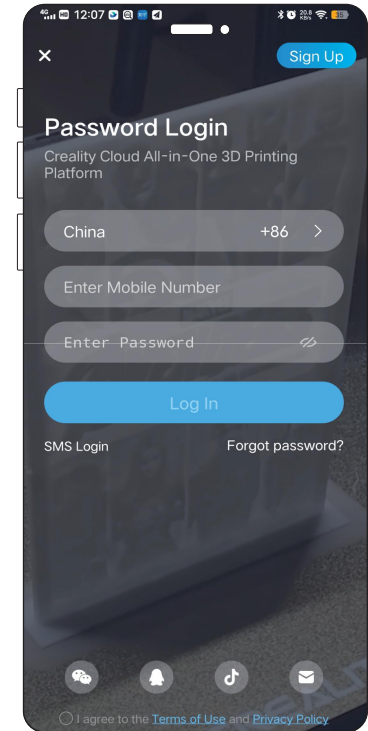

- 3 Log in

4. First Printing

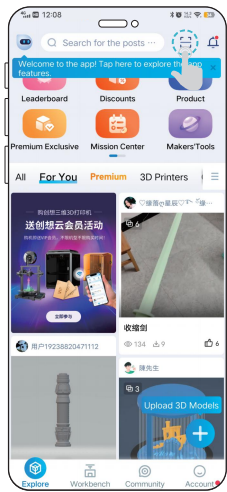

4 Add a new device

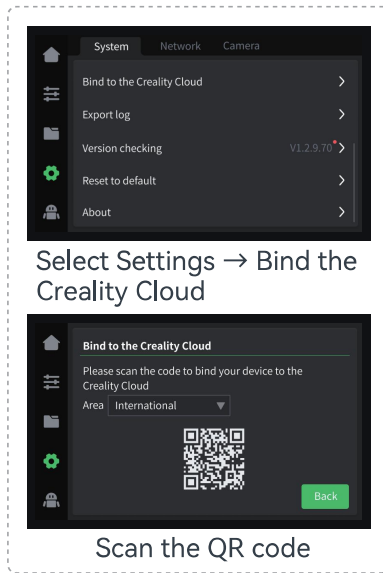

Select Settings → Bind the Creativity Cloud

Scan the QR code



5 Added successfully

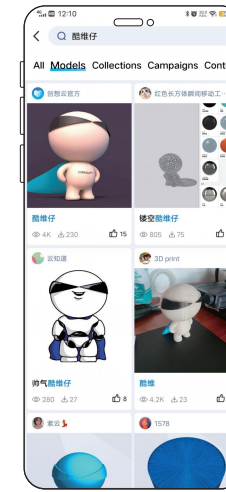

6 Select model on the homepage



7 Slice

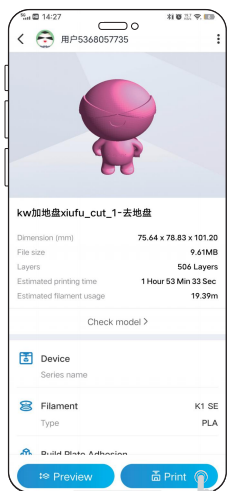

8 Print

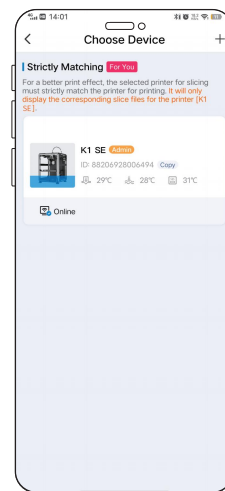

9 Select a device

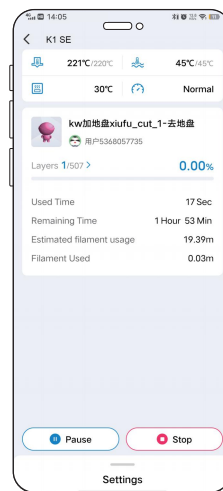

10 Printing...



The current interface is for reference only. Due to the continuous upgrading of functions, it shall be subject to the latest software/firmware UI published on the official website.

5. Functional Specification

5.1 Extrude, Filament Retreat

Extrude

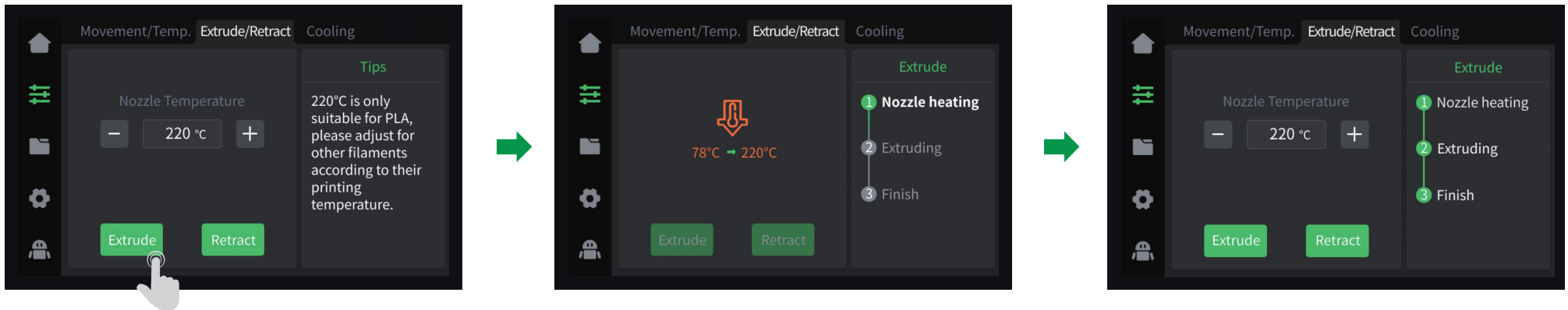

Filament Retreat

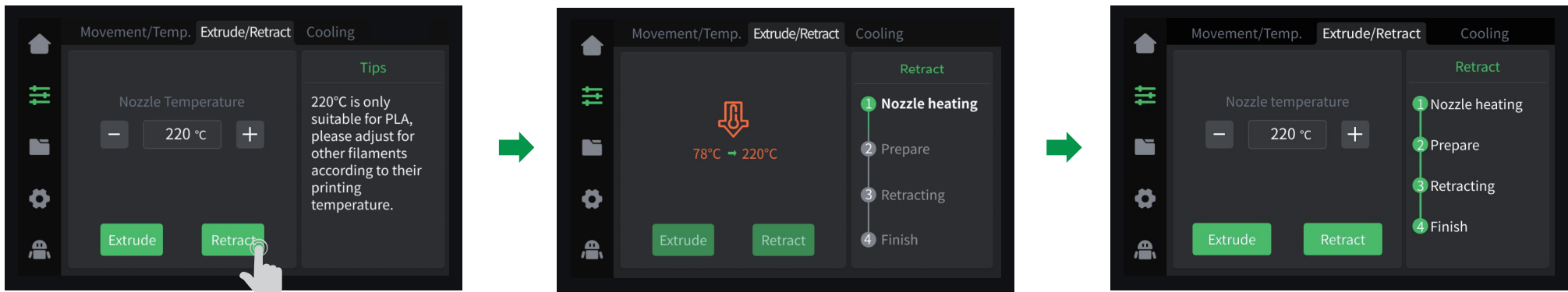

NOTE: The nozzle temperature must be set according to the filament properties.



The current interface is for reference only. Due to the continuous upgrading of functions, it shall be subject to the latest software/firmware UI published on the official website.

6. Tips and Routine Maintenance



6.1 Maintenance Items

Maintenance instructions		
Machine cleanup	Clean the debris inside the machine to ensure that its operation is not affected.	Before each print
Hot end	Solution to extruder blockage: After preheating and removing the filaments, raise the temperature of the extruder and poke into the extruder from top to bottom using an extruder cleaner until the blocked filaments are poked out.	After extruder blockage
	Replace the nozzle.	Cumulative print time per 500 hours
	Check if the wire output is normal, if not, please check if the extruder is blocked.	After each change of filaments
	Check the nozzle for filament residue, if so, heat the nozzle and remove it with a tool.	Before each print
Printing platform	Check the surface of the platform for residual filaments and glue, if so, clean the surface of the platform.	Before each print
Motion mechanism	XYZ optic axis lubrication.	Cumulative print time per 500 hours
Equipment self-test	Axis movement.	Cumulative print time per 300 hours
	Optimization of vibration veins.	
	Auto Leveling.	
Filament replacement	Replacement of filaments of the same kind: follow the normal Retreat - Feed process.	/
	Replacement of different filaments: Preheat the nozzle to reach the target temperature of the current filament; then retreat it, replace with the target filament, and preheat the nozzle to the higher filament extrude temperature of the two filaments; feed for 30s until the filament has been completely extruded, and finally set the nozzle temperature to the temperature of current filament nozzle.	

If the above issues cannot be resolved:

- ① You can log in to the Creality Official Wiki (<https://wiki.creality.com>) to explore more detailed after-sales service tutorials.
- ② Or contact our after-sales service center at +86 755 3396 5666, or send e-mail to cs@creality.com.

6. Tips and Routine Maintenance

6.2 Precautions for printing

6.2.1 Lubrication and maintenance

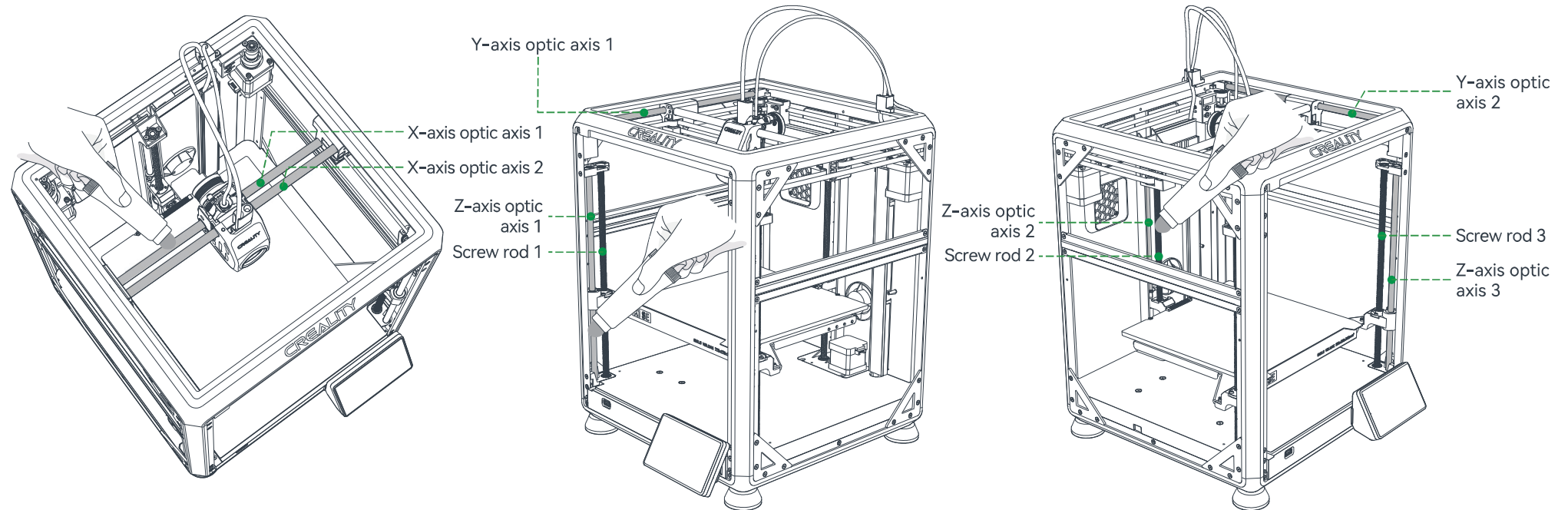

Tips: please grease and lubricate the designated areas regularly (as shown in the picture). (Users may buy the grease themselves for machine maintenance.)

6. Tips and Routine Maintenance

6.2.2 Use and maintenance of flexible platform

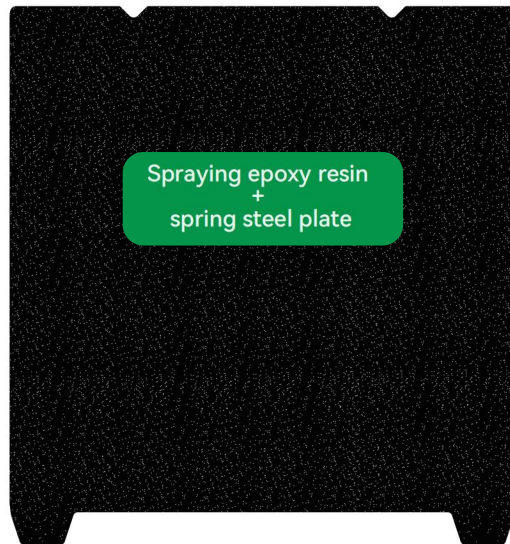

Features

- Stronger model adhesion, easy to remove the model after printing.
- Double-sided epoxy resin coating, both sides can be used for printing.
- Epoxy resin coating does not blister, textured surface is easy to clean.

Precautions for use

- If the heated bed temperature is too low during printing, poor adhesion may occur.
- If there is oil or hand sweat on the platform surface, poor adhesion may occur.
 - Excessive nozzle pressure or forcefully removing the model with a metal spatula can easily damage the epoxy coating.



If you want to buy the above flexible platform, you can enter the mall <https://vip.creality.com/en/goods-detail/2105> for purchase.

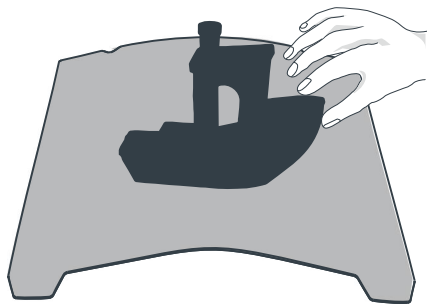

- 1 Together with the flexible platform after the printed model has been cooled down Remove from the device and partially bend the platform slightly to separate the model from the platform.(No excessive bending of the platform to prevent it from being deformed and unusable)

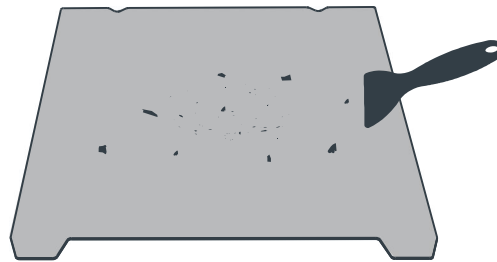

- 2 The residue of the platform filaments can be scraped off with a blade. Be cautious of safety when using.

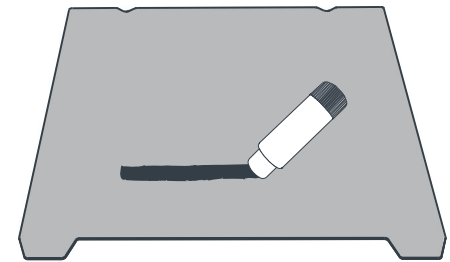

- 3 When the first layer of the model is not glued, it is recommended to apply glue stick evenly on the surface of the platform.



Reminder: Since the printing platform is quick-wear, it is recommended to replace the printing platform regularly to ensure that the first layer of the model is adhered.

6. Tips and Routine Maintenance

6.2.3 Cleaning of debris inside the chassis

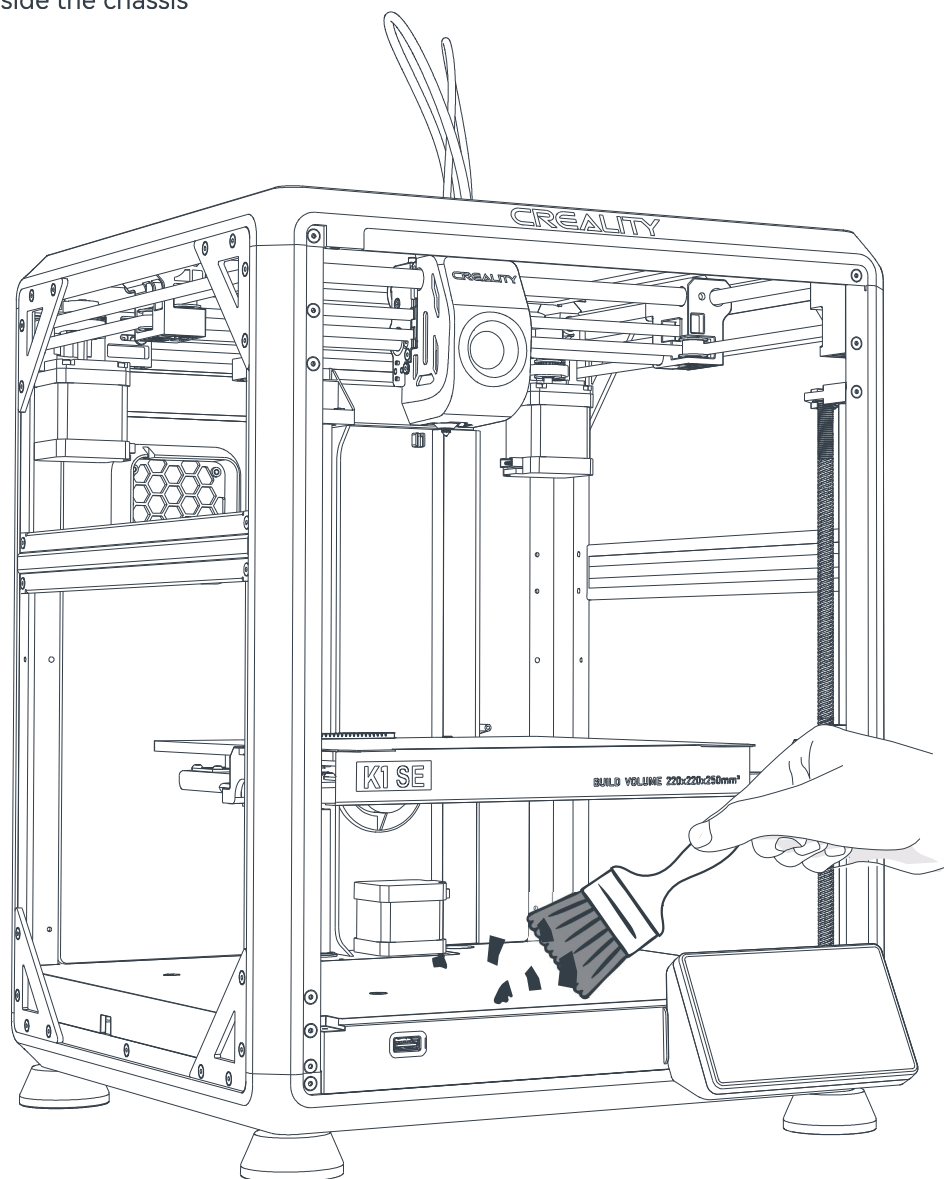

Due to the differences between different machine models, the actual objects and the images can differ. Please refer to the actual machine. The final explanation rights shall be reserved by Shenzhen Creality 3D Technology Co., Ltd.



SHENZHEN CREALITY 3D TECHNOLOGY CO., LTD.

18th Floor, JinXiuHongDu Building, Meilong Road, Xiniu Community,
Minzhi Street, Longhua District, Shenzhen City, China.

Official Website: www.creality.com

Tel: +86 755-8523 4565

E-mail: cs@creality.com



R 214-126408

