

User Guide

JONSBO

Anwenderleitfaden / Guide de l'utilisateur

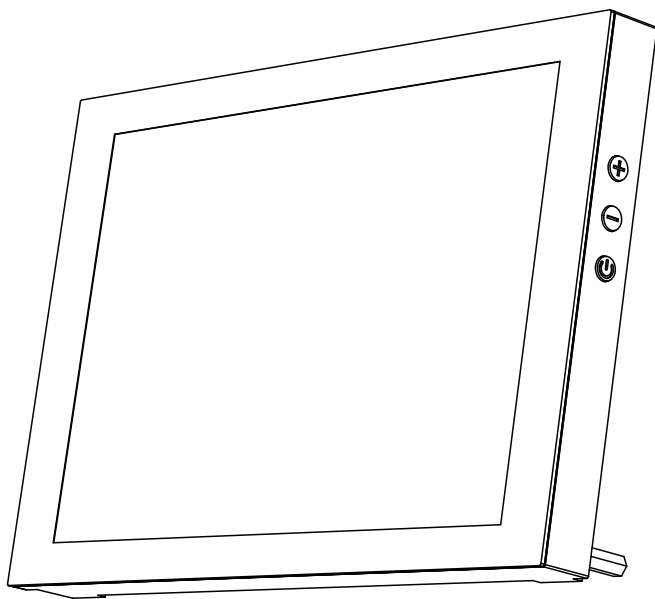





用戶指南



D31/D41 SCREEN

www.jonsbo.com

Secondary screen chassis-screen functional accessories list

<p>A</p>  <p>8" display secondary screen</p> <p>x1</p>	<p>D</p>  <p>HDMI to Mini-HDMI data cable</p> <p>x1</p>
<p>B</p>  <p>HEX wrench socket * In the case's accessory bag</p> <p>x1</p>	<p>E</p>  <p>USB Type-A to USB Type-C Power cable</p> <p>x1</p>
<p>C</p>  <p>Long standoff</p> <p>x2</p>	<p>F</p>  <p>Replacement case front bezel</p> <p>x1</p>

*Software not included, "Wallpaper engine" is recommended for wallpaper related, and "AIDA64 extreme" is recommended for hardware monitoring software

*Interface skin for "ADIA64 Extreme can be downloaded from Jonsbo's official website (<https://www.jonsbo.com/en/products/D31.html>), and loaded for use, can also be designed by yourself.

*It is recommended to use Microsoft Windows OS. If you use other operating systems, you need to set/adapt the function of the secondary screen by yourself

Secondary screen specifications

- Product size: 24.6mm(W) x 131.7(H) x 205.3(L)
- Display size: 8" Color TFT-LCD
- Colors: 16.7M
- Resolution: 1280*800
- Aspect ratio: 16:10

Button function introduction

- screen brightness +
- Screen Brightness
- Turn off the screen backlight

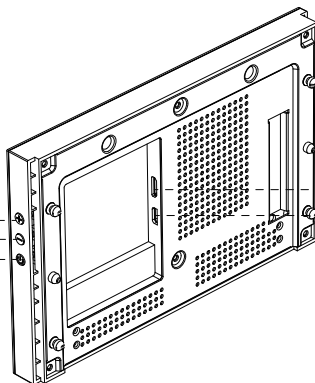

Interface Description

Mini-HDMI

TYPE-C

Secondary screen installation: can be used independently or externally, or installed on the chassis panel

Steps for using the secondary screen externally

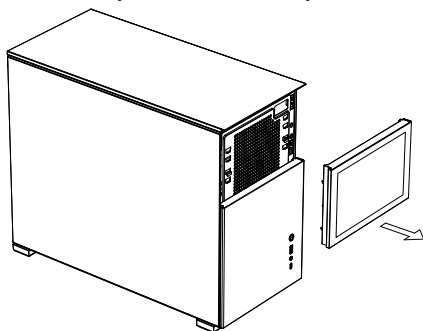

1-1

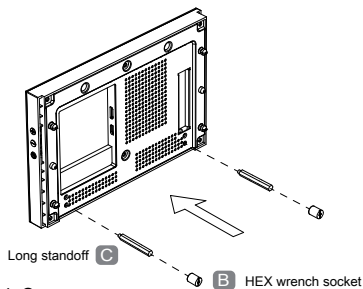

1-2

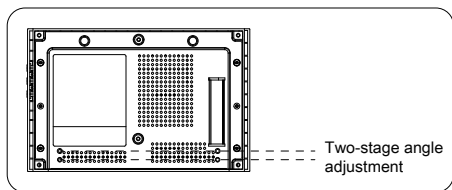

1-3 Complete the installation of computer hardware and operating system software by referring to the "Case Installation Instructions". When Microsoft Windows system is started for the first time, don't connect the secondary screen to the system, so as to prevent the host from misidentifying the main display.

After the system starts up and the main monitor displays normally, connect the secondary screen MINI-HDMI and TYPE-C interfaces.

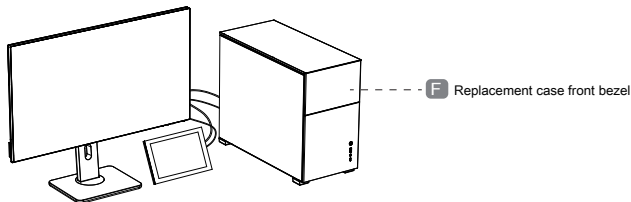

1-4

* The LCD secondary screen needs to be connected to the HDMI port x1 of the graphics card. If the number of host ports is insufficient, you need to purchase a suitable adapter cable, such as "DisplayPort male to HDMI female".

Secondary screen installation: can be used independently or externally, or installed on the chassis panel

The steps for installing the secondary screen in the chassis

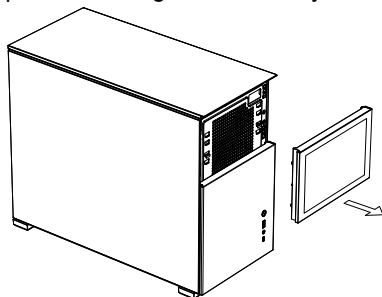

1-1

Before using the secondary screen, you need to use the primary monitor to complete the operating system installation. After connecting the secondary screen cable, set the primary monitor of your desktop as the "primary monitor" in the system according to the subsequent steps of this manual.

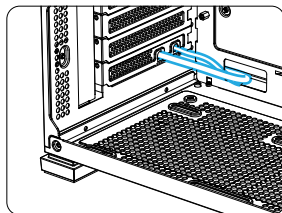
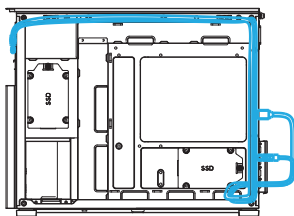

1-2

Before assembling the hardware, it is necessary to complete the pre-installation of HDMI and TYPE-C cables to avoid difficulty in threading/routing after installing the motherboard and other hardware. When starting the Microsoft Windows system for the first time, do not connect the port of the secondary screen to prevent the host from misidentifying the main monitor.

After the system starts up and the main monitor displays normally, connect the secondary screen with MINI-HDMI and TYPE-C cable to the system

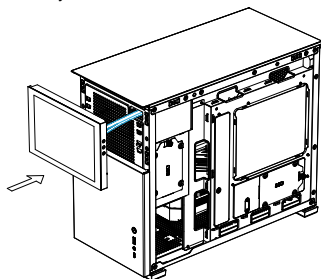
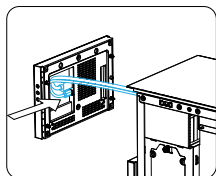
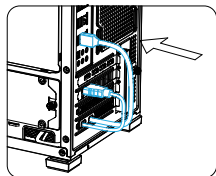

1-3

* The LCD secondary screen needs to be connected to the HDMI port x1 of the graphics card. If the number of host ports is insufficient, you need to purchase a suitable adapter cable, such as "DisplayPort male to HDMI female".

Start the system and set the secondary screen display in the Microsoft WINDOWS system

1. The secondary screen manual will be updated in real time based on user feedback. Please visit <https://www.jonsbo.com/en/products/D31.html>, or scan the QR code below to get detailed graphic instructions.



D31_SCREEN_USER_GUIDE.PDF



D31_SCREEN_USER_GUIDE.DOC

2. Vertical to horizontal display settings for the secondary screen : right-click the desktop of the main screen to pop up a menu, click "Display settings" - "Identify", select the icon whose serial number is the secondary screen, slide down the menu, and change the "Portrait" in the display direction to For "Landscape (flipped)", and finally "Keep changes". After the screen is displayed in landscape orientation, check the zoom setting of the secondary screen and adjust it to 100%.

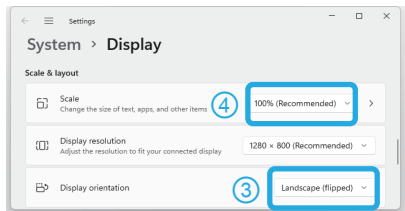
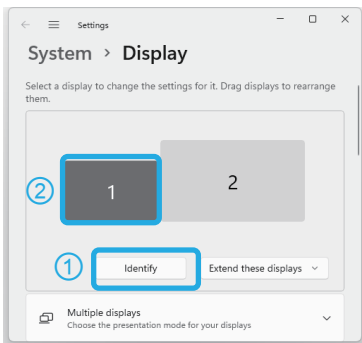

3. Select the secondary screen indicator icon in the settings menu, you can drag it around the main screen for positioning, which is usually consistent with the actual position of the main/secondary screen. After adjustment, click "Apply".

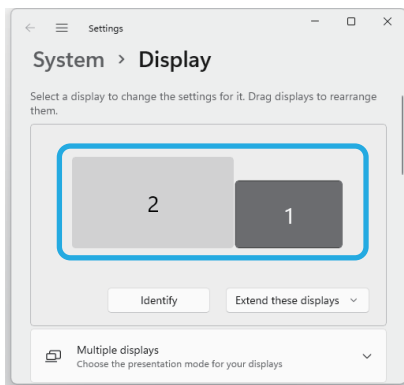

Start the system and set the secondary screen display in the Microsoft WINDOWS system

4. Check the rest of the settings: select "Extend these displays" for multi-display mode, and "Make this my main display" for the main screen.

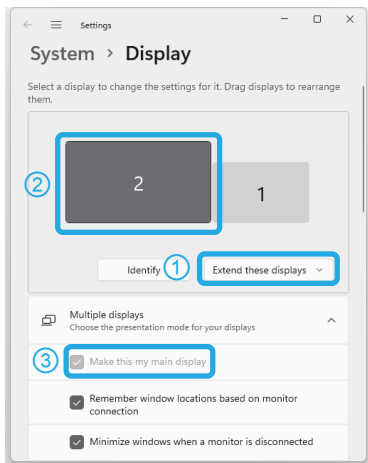

5. Right-click on the taskbar at the bottom of the main screen desktop, select "Taskbar settings" from the pop-up menu, scroll down to expand "Taskbar behaviors", uncheck the "Taskbar behaviors" option, and confirm that the taskbar below the secondary screen has disappeared.

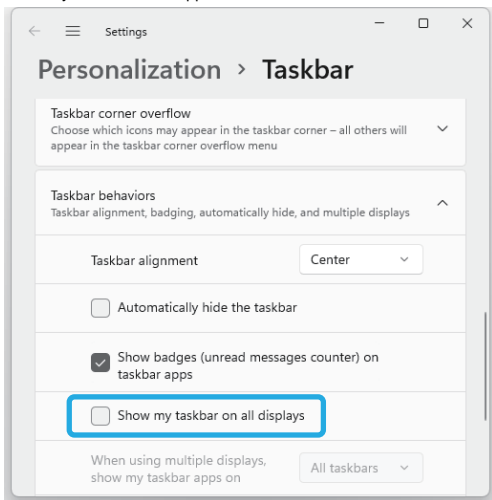

Software User Guide

This secondary screen can be combined with third-party software, such as Wallpaper Engine, to realize dynamic video/picture display function; or combined with AIDA64 Extreme to realize hardware status monitoring. For more detailed instructions, please visit <https://www.jonsbo.com/en/products/D31.html>, or scan the QR code below for detailed graphic instructions.



D31_SCREEN_USER_GUIDE.PDF



D31_SCREEN_USER_GUIDE.DOC

Wallpaper Engine Live Wallpaper Setup Guide

- 1.To buy/install Wallpaper Engine software from STEAM platform, STEAM platform official website address: <https://store.steampowered.com/>
- 2.Start the software, in the pop-up "Choose Display" setting interface, select the secondary screen or the main screen you want to set wallpaper, and then click "Change Wallpaper".

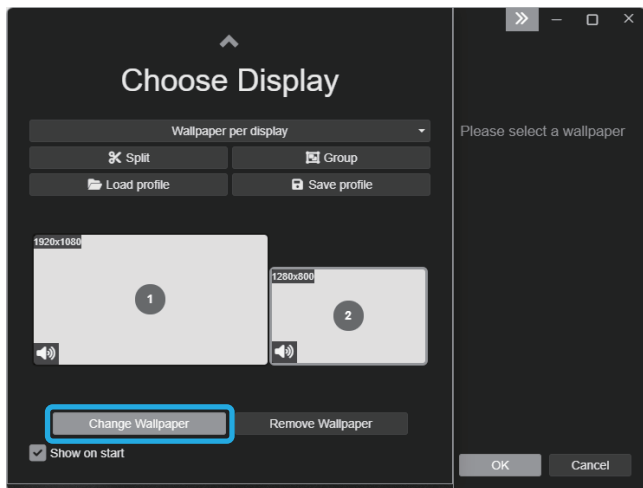

- 3.Choose your favorite wallpaper and click "Subscribe" on the right.

4. In the setting interface of Wallpaper Engine, you can adjust the display logic/display quality as needed to reduce the consumption of system resources (available for low performance system, usually no separate settings are required).

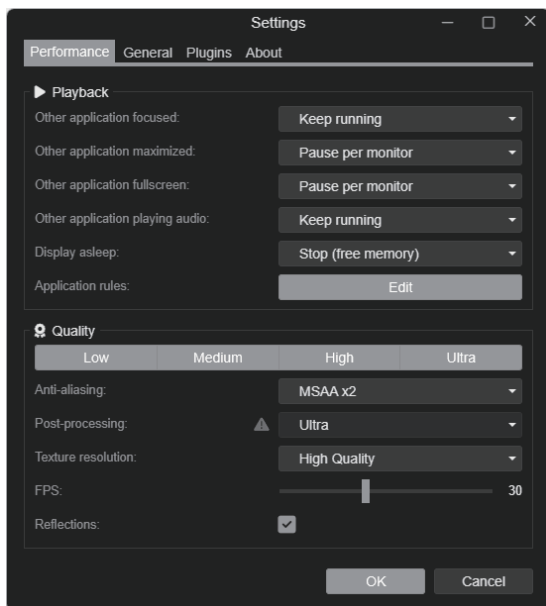

5. Setup is complete.

1. Install AIDA64 Extreme software and register for activation.

2. Through <https://www.jonsbo.com/Upfiles/down/sensorpanel.zip> or the QR code below, download the configuration file with the suffix format "xxxxxx.sensorpanel".



3. In the "File" - "Preferences" - "General" settings, check the following items, and click "Apply":

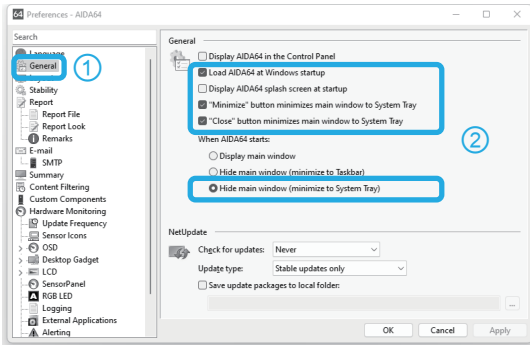

- Load AIDA64 at Windows startup
- "Minimize" button minimizes main window to System Tray
- "Close" button minimizes main window to System Tray
- Hide main window (minimize to System Tray)

4. In "Hardware Monitoring" - "SensorPanel" setting, check the following items and click "Apply":

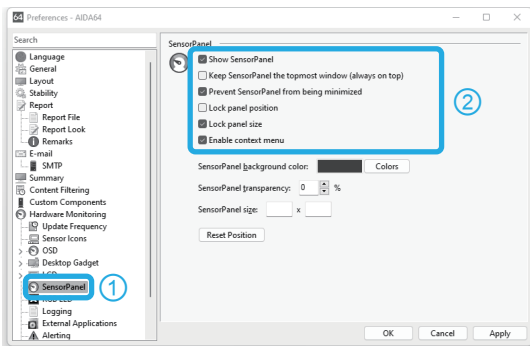

- Show SensorPanel
- Prevent SensorPanel from being minimized
- Lock panel size
- Enable context menu

5. In the pop-up monitoring initial interface, right-click the pop-up menu, select "SensorPanel Manager", select "Import", select the downloaded configuration file with the suffix "xxxxxx.sensorpanel", and select "Open". "Yes".

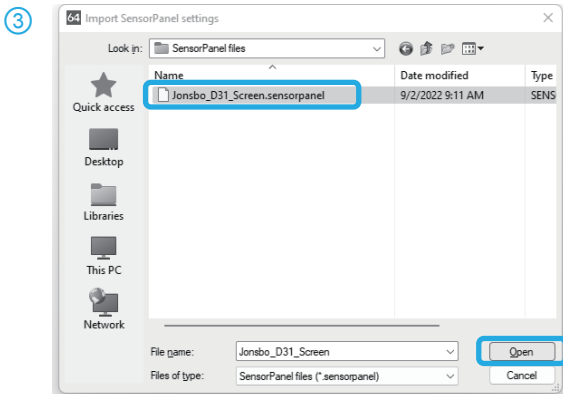
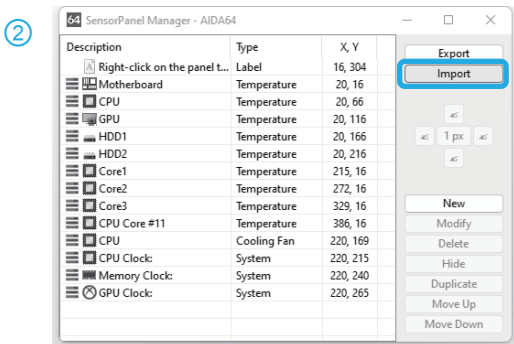
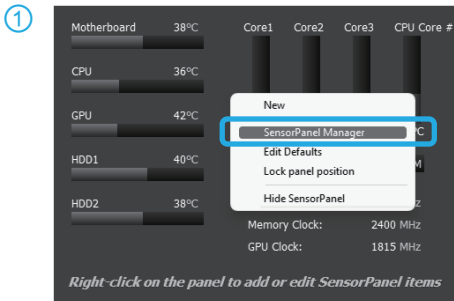

AIDA64 Extreme Monitoring Interface Setup Guide

6. Under different display (main screen) resolutions/scaling ratios, the icons and texts of the monitoring interface may be displayed in dislocation. Adjustment method: Open the AIDA64 installation directory, the default installation address is "C:\Program Files (x86)\FinalWire\AIDA64 Extreme", Right-click the icon of the main program "aida64.exe", and select "Properties"->"Compatibility"->"Change settings for all users"->"Change high DPI settings"-check "Override high DPI scaling behavior" in the pop-up menu .scaling performed by:" - Select "System (Enhanced)" and step by step "Apply" the modified settings menu. Finally, right-click the AIDA64 program icon in the lower right corner of the desktop, select "Exit" and restart the program.

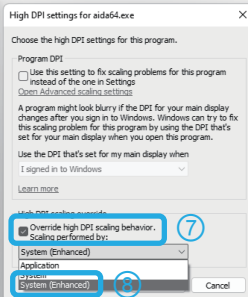
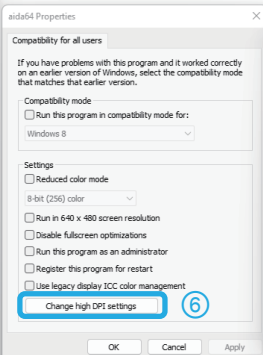
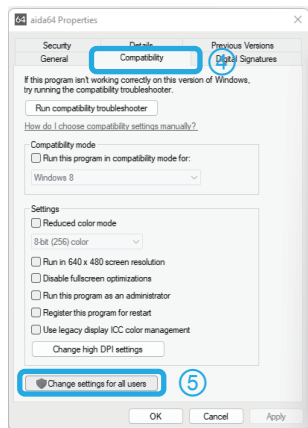
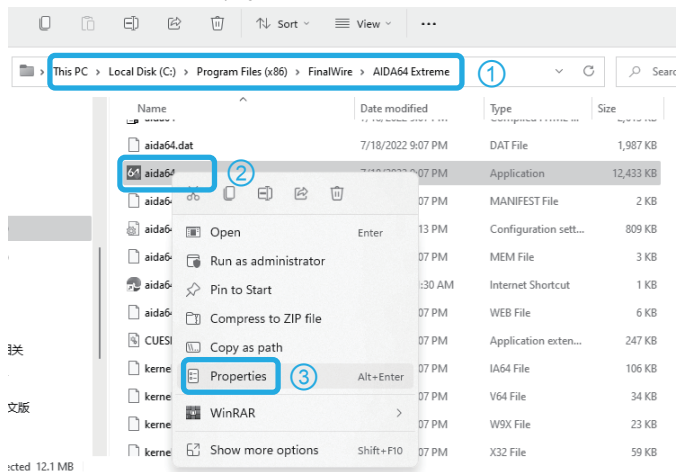

7. Select and drag the configured monitoring interface to the secondary screen with the left mouse button, and align it with the edge of the display area of the secondary screen.

Note: When the main display is running with high resolution such as 2K/4K, if the mouse cannot be adaptively reduced when moving the monitoring interface to the secondary screen, please minimize all the interfaces of the AIDA64 software first, and then perform the mouse drag operation.

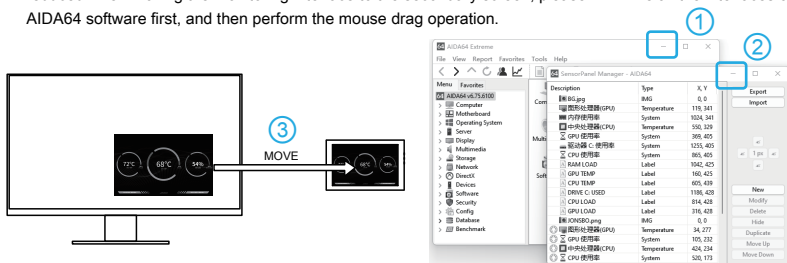

8. In the main interface of AIDA64 Extreme software "File" - "Preferences" - "Hardware Monitoring" - "SensorPanel" settings, check the following items and click "Apply".

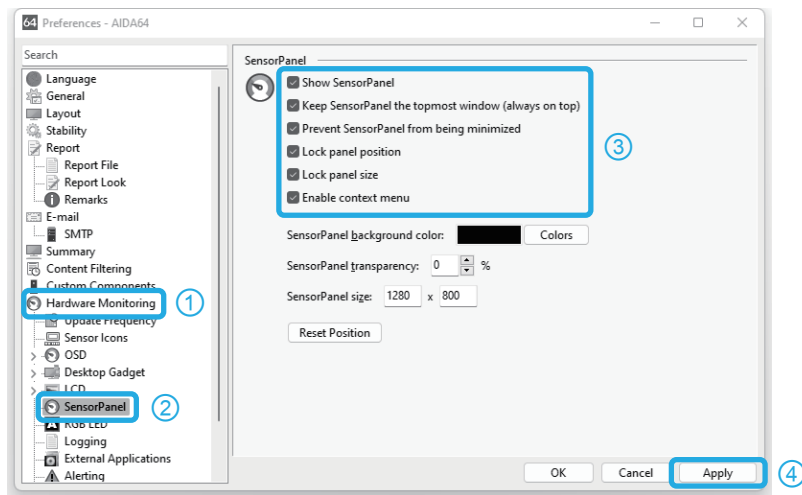

- Keep SensorPanel the topmost window (always on top) *This item is selected according to personal usage habits
- Lock panel position

9. Setup is complete.

System Settings FAQ

The secondary screen manual will be updated in real time based on user feedback. Please visit <https://www.jonsbo.com/en/products/D31.html>, or scan the QR code below to get detailed graphic instructions.



D31_SCREEN_USER_GUIDE.PDF



D31_SCREEN_USER_GUIDE.DOC

- How to solve the problem that the secondary screen becomes the main screen? ----- page 5
- The display direction of the secondary screen is wrong? ----- page 4
- How to set the position of the secondary screen and the main screen to be consistent with the actual placement, so that the mouse operation window movement is more convenient? ----- page 4
- The number of HDMI ports on the graphics card is not enough to connect the secondary screen and the main screen at the same time? ----- page 3, Adapter cable to be purchased separately

Question for using Wallpaper Engine

- How to set automatic pause for wallpaper display to avoid excessive consumption of system resources?
----- page 4

Question for using AIDA64

- AIDA64 monitoring interface icons, text, etc. are misplaced, and the display is abnormal? ----- page 10
- My system is in traditional Chinese or other languages, and the monitoring interface displays garbled characters?
----- "File" - "Preferences" - "Language" - select the language corresponding to the windows system
- AIDA64 cannot read a certain hardware parameter? ----- Right-click the monitoring interface - select "SensorPanel Manager" - double-click the unreadable item - replace with an item that can read the data correctly - export a new configuration file
- The opened program or window cannot be displayed on the main screen? ----- Right-click the AIDA64 icon in the lower right corner of the desktop - select "Hide SensorPanel" - remove the program window covered by the monitoring interface - select "Show SensorPanel" again
- When the monitoring interface is dragged to the secondary screen, the size cannot be adapted? ----- page 4/10/11

JONSBØ

www.jonsbo.com