

User Guide

JONSBO

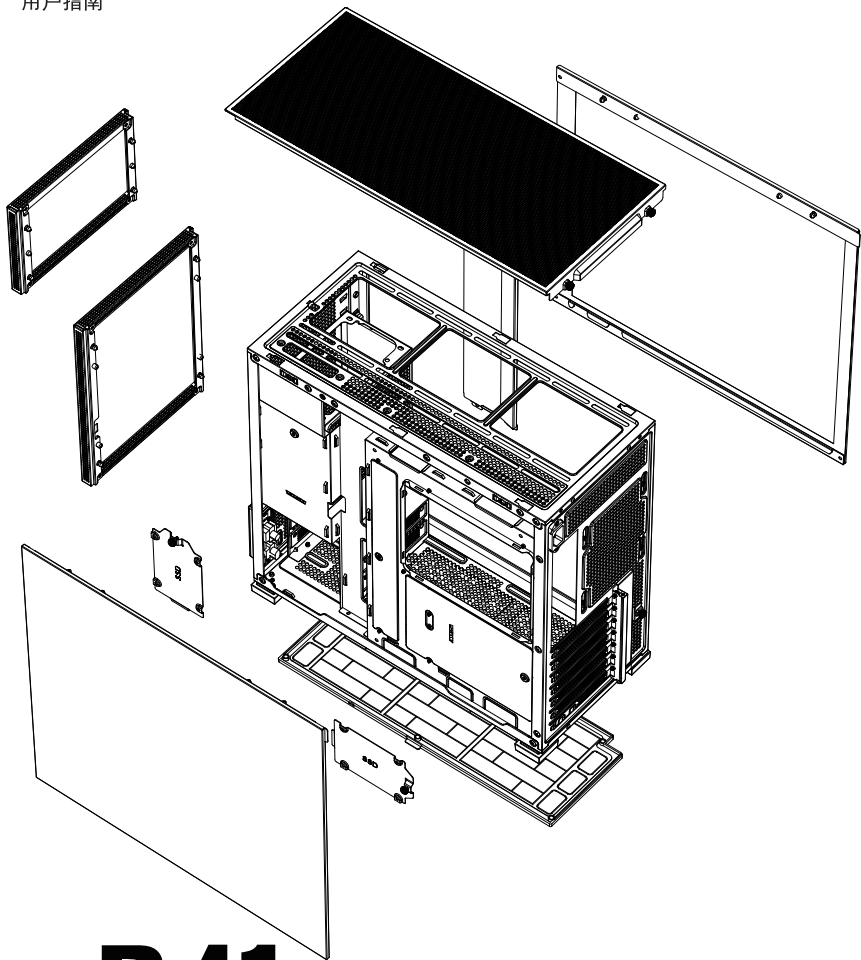







Anwenderleitfaden / Guide de l'utilisateur

用戶指南







D41 Computer Case

www.jonsbo.com

<p>A</p>  <p>Motherboard Screws Motherboard-Schrauben Vis de la carte mère 鎖主機板螺絲</p> <p>x12</p>	<p>F</p>  <p>Spare panel mounting clip / Ersatz-Panel-Montageclip / Clip de montage de panneau de rechange / 備用鉚釘卡扣</p> <p>x2</p>
<p>B</p>  <p>2.5" SSD Screws 2,5" SSD Schrauben Vis SSD 2,5" 鎖2.5" SSD螺絲</p> <p>x15</p>	<p>G</p>  <p>Cable Tie Kabelbinder Attache de cable 束線帶</p> <p>x10</p>
<p>C</p>  <p>3.5" HDD Screws 3,5-Zoll-Festplattenschrauben Vis pour disque dur 3,5" 鎖3.5" HDD硬碟螺絲</p> <p>x9</p>	<p>H</p>  <p>Motherboard Standoff Motherboard-Abstand Entretoise de la carte mère 鎖主板備用銅柱</p> <p>x2</p>
<p>D</p>  <p>3.5" HDD Rubber Grommet/ 3,5" HDD Gummitülle/ Passe-fil en caoutchouc pour disque dur 3,5"/ 3.5" HDD硬碟膠墊</p> <p>x9</p>	<p>I</p>  <p>HEX Socket HEX-Buchse Douille hexagonale 六角套筒</p> <p>x1</p>
<p>E</p>  <p>PSU Screws Netzteil Schrauben Vis d'alimentation 鎖電源螺絲</p> <p>x6</p>	

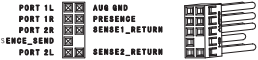
Connectors - Anschluss - Connecteurs - 連接器

<p>USB 3.0 Connection</p> 	<p>Type-C Connection</p> 	<p>HD AUDIO Connection</p> 
<p>Power Button Connection</p> 	<p>Power LED Connection</p> 	

D41 is divided into a version with a screen and a version without a screen. If you purchased a screen version, you need to refer to the screen manual first. Before installing the motherboard, pre-install the HDMI and TYPE-C cables in advance /

D41 ist in eine Version mit Bildschirm und eine Version ohne Bildschirm unterteilt. Wenn Sie eine Bildschirmversion gekauft haben, müssen Sie zuerst das Bildschirmhandbuch zu Rate ziehen. Installieren Sie vor der Installation des Motherboards die HDMI- und TYPE-C-Kabel im Voraus /

Le D41 se décline en une version avec écran et une version sans écran. Si vous avez acheté une version écran, vous devez d'abord vous référer au manuel de l'écran. Avant d'installer la carte mère, pré-installez les câbles HDMI et TYPE-C à l'avance /

D41 分為帶屏幕和不帶屏幕版本，如果您購買的是屏幕版本，需要先參考屏幕說明書，在安裝主機板之前，請提前預裝HDMI與TYPE-C線纜。

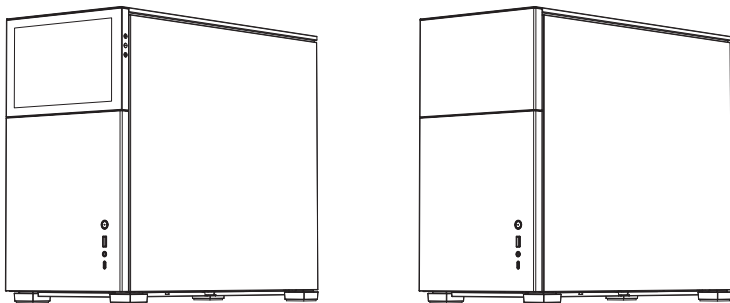

Chassis Specs - Chassis-Spezifikationen - Spécifications du chassis - 主機殼規格

Case size: 205mm(W)*407mm(H)*452mm(D)
Drive bays: 2.5" SSD*3, 3.5" HDD*2
Motherboard Support: ITX / M-ATX / ATX
PCI expansion slots: 7
Front I/O Port: USB 3.2 Gen 2 Type-C*1 / USB3.0*1 / Audio&Mic*1
Power supply support: ATX / SFX, 220mm L max.
*Depends on the position of PSU compartment
CPU cooler support: 168mm H max.
Graphics card support: 330mm~400mm
*Depends on the position of PSU compartment
Radiator support:
Top 240/280/360
Rear 120
Bottom 240/360
Fan mounting position:
Front 120mm*1(optional)
Top 120mm*3/140mm*2(optional)
Rear 120mm*1 (optional)
Bottom 120mm*3/140mm*2(optional)

Hardware installation preparation
Hardware installation preparation
Préparation de l'installation du matériel
硬件安裝準備工作

Remove Side Panel / Seitenwand entfernen / Retirer le panneau lateral / 移除側板

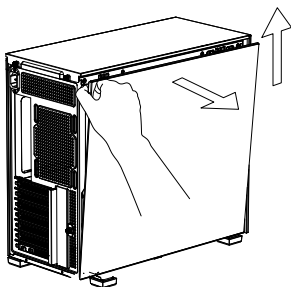

1-1

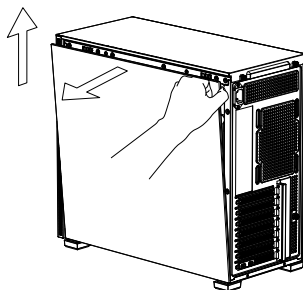

1-2

Remove Top Cover / Entfernen Sie die obere Abdeckung / Retirer le capot supérieur / 移除上蓋

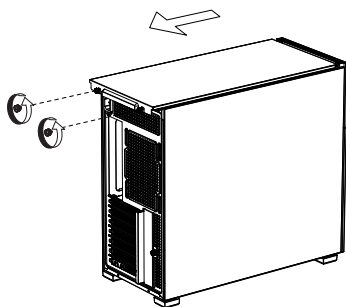

1-1

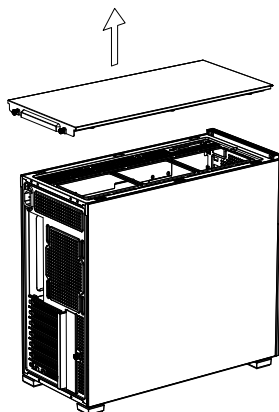

1-2

Hardware installation preparation
Hardware installation preparation
Préparation de l'installation du matériel
硬件安裝準備工作

Remove the inner side panel / Entfernen Sie die innere Seitenwand /
Retirer le panneau latéral intérieur / 移除內部側擋板

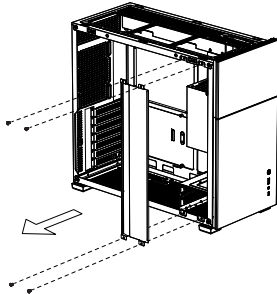

Remove Front Panel / Entfernen Sie die Frontplatte / Retirer le panneau avant / 移除前板

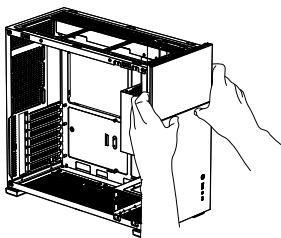

1-1

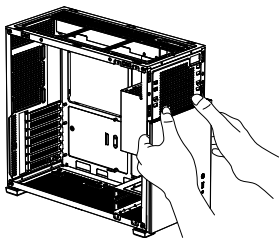
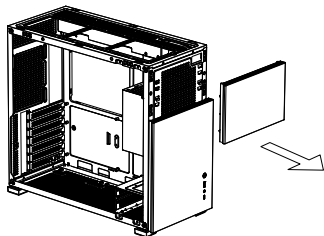

1-2

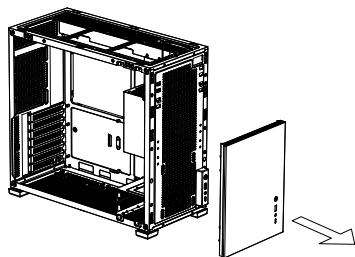

Hardware installation preparation
Hardware installation preparation
Préparation de l'installation du matériel
硬件安裝準備工作

Remove the power supply bracket / Entfernen Sie die Netzteilhalterung /
Retirez le support d'alimentation / 拆除電源架

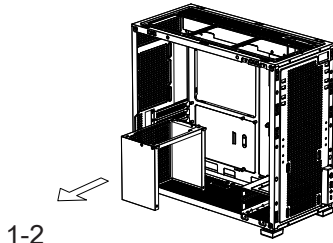
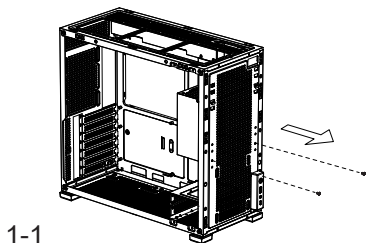

Remove the dust filter / Entfernen Sie den Staubfilter / Retirez le filtre à poussière / 移除防塵網

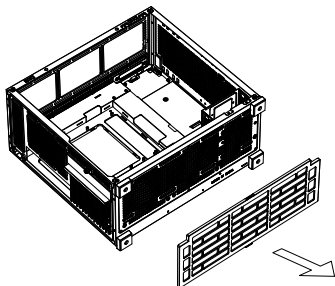

Remove the HDD cage / Entfernen Sie den Festplattenkäfig / Retirez la cage du disque dur /
移除硬盤倉

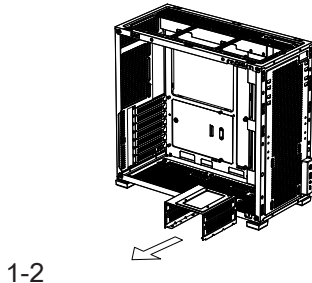
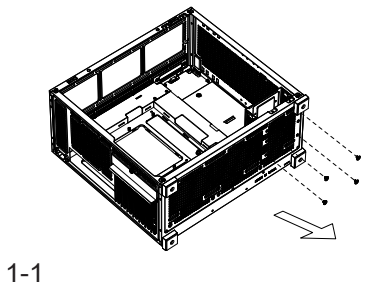

Motherboard / Radiator Installation
Mainboard- / Kühlerinstallation
Installation de la carte mère / du radiateur
主機板 / 水冷安裝步驟

Motherboard Installation / Motherboard-Installation /
Installation de la carte mère / 主機板安裝

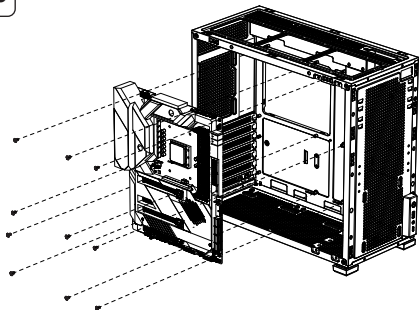

Radiator installation / Kühlerbau / Installation de radiateur / 水冷安裝

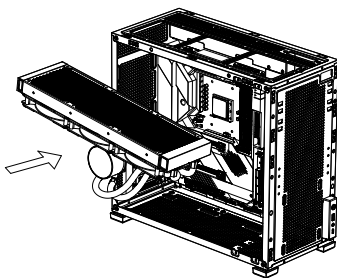

1-1

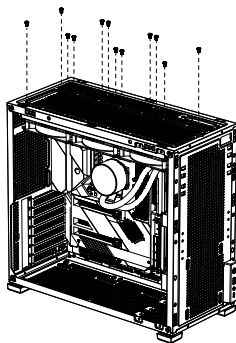

1-2

PSU installation steps
 Installationsschritte für das Netzteil
 Étapes d'installation du bloc d'alimentation
 電源安裝步驟

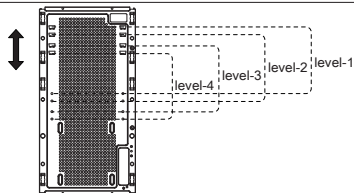

Power supply rack with 4-level height adjustment/
 Netzteil-Rack mit 4-stufiger Höhenverstellung/
 Rack d'alimentation avec réglage en hauteur
 sur 4 niveaux/
 電源架可進行4級高度調節

D41 installs the MATX motherboard, and the graphics card is installed in the first PCI-E slot of the chassis /

D41 installiert das MATX-Motherboard und die Grafikkarte wird im ersten PCI-E-Steckplatz des Gehäuses installiert /

D41 installe la carte mère MATX et la carte graphique est installée dans le premier emplacement PCI-E du chassis /

D41安裝MATX主板,顯卡安裝於機箱第一條PCI-E位置

English

AIO		PSU	≤14cm	≤15cm	≤16cm	≥18cm
240 / 280 AIO	Power supply suitable at	level-1	level-1	level-1	level-1	level-1
	Graphics card length limit	400mm	342~360mm	342~360mm	335mm	335mm
360 AIO	Power supply suitable at	level-3	level-3	level-3	level-3	level-3
	Graphics card length limit	342~360mm	335mm	335mm	335mm	335mm

When the length of the graphics card is less than or equal to 330mm, the power supply can be installed in the level-4 hanging position.

When three 12CM fans are installed on the top, the power supply can be installed in the level-2 hanging position.

Note: The calculated length of the graphics card is the total length including the PCI-E bracket.

Note: The length limit of the graphics card depends on the installation direction of the power supply.

Note: If 360 AIO is installed under the top cover, it is recommended to use a power supply length of 14CM to obtain a longer graphics card installation space.

PSU installation steps
 Installationsschritte für das Netzteil
 Étapes d'installation du bloc d'alimentation
 電源安裝步驟

Deutsch

AIO		PSU	≤14cm	≤15cm	≤16cm	≥18cm
240 / 280 AIO	Netzteil geeignet für		level-1	level-1	level-1	level-1
	Maximale Grafikkartlänge		400mm	342~360mm	342~360mm	335mm
360 AIO	Netzteil geeignet für		level-3	level-3	level-3	level-3
	Maximale Grafikkartlänge		342~360mm	335mm	335mm	335mm
Wenn die Länge der Grafikkarte kleiner oder gleich 330 mm ist, kann das Netzteil in der Level-4-Hängeposition installiert werden. Wenn drei 12-CM-Lüfter oben installiert sind, kann das Netzteil in der Hängeposition der Ebene 2 installiert werden.						
Hinweis: Die berechnete Länge der Grafikkarte ist die Gesamtlänge inklusive PCI-E-Bracket. Hinweis: Die Längenbegrenzung der Grafikkarte hängt von der Einbaurichtung des Netzteils ab. Hinweis: Wenn 360 AIO unter der oberen Abdeckung installiert ist, wird empfohlen, eine Netzteillänge von 14 cm zu verwenden, um einen längeren Installationsraum für die Grafikkarte zu erhalten.						

Français

AIO		PSU	≤14cm	≤15cm	≤16cm	≥18cm
240 / 280 AIO	Alimentation adaptée au		Niveau-1	Niveau-1	Niveau-1	Niveau-1
	Limite de longueur de la carte graphique		400mm	342~360mm	342~360mm	335mm
360 AIO	Alimentation adaptée au		Niveau-3	Niveau-3	Niveau-3	Niveau-3
	Limite de longueur de la carte graphique		342~360mm	335mm	335mm	335mm
Lorsque la longueur de la carte graphique est inférieure ou égale à 330 mm, l'alimentation peut être installée en position suspendue de niveau 4. Lorsque trois ventilateurs de 12 cm sont installés sur le dessus, l'alimentation peut être installée en position suspendue de niveau 2.						
Remarque : La longueur calculée de la carte graphique est la longueur totale, y compris le support PCI-E. Remarque : La limite de longueur de la carte graphique dépend du sens d'installation de l'alimentation. Remarque : Si 360 AIO est installé sous le capot supérieur, il est recommandé d'utiliser une longueur d'alimentation de 14 cm pour obtenir un espace d'installation de carte graphique plus long.						

中文

水冷		電源	≤14cm	≤15cm	≤16cm	≥18cm
240 / 280 AIO	電源適合等級		level-1	level-1	level-1	level-1
	顯卡限長		400mm	342~360mm	342~360mm	335mm
360 AIO	電源適合等級		level-3	level-3	level-3	level-3
	顯卡限長		342~360mm	335mm	335mm	335mm
當顯卡長度≤330mm時，可將電源安裝於第4級掛位。 當頂部安裝3個12CM風扇時，可將電源安裝於第2級掛位。						
注意：顯卡計算長度為包含PCI-E擴片的總長度。 注意：顯卡長度取決於電源安裝方向。 注意：頂部如果安裝360AIO，則建議搭配電源長度為14CM，可獲得較長的顯卡安裝空間。						

PSU installation steps
 Installationsschritte für das Netzteil
 Étapes d'installation du bloc d'alimentation
 電源安裝步驟

D41 is installed with ATX or MATX motherboard, and the graphics card is installed in the second PCI-E slot of the chassis /

D41 wird mit ATX- oder MATX-Motherboard installiert, und die Grafikkarte wird im zweiten PCI-E-Steckplatz des Gehäuses installiert /

D41 est installé avec une carte mère ATX ou MATX et la carte graphique est installée dans le deuxième emplacement PCI-E du châssis /

D41安裝ATX或MATX主板,顯卡安裝於機箱第二條PCI-E位置

English

AIO		PSU	≤14cm	≤15cm	≤16cm	≤18cm
240 / 280 AIO	Power supply suitable at	level-1	level-1	level-1	level-1	level-1
	Graphics card length limit	400mm	400mm	400mm	400mm	342~360mm
360 AIO	Power supply suitable at	level-3 or 4	level-3	level-3	level-3	level-3
	Graphics card length limit	342~360mm	342~360mm	342~360mm	342~360mm	335mm
When the length of the graphics card is less than or equal to 330mm, the power supply can be installed in the level-4 hanging position.						
When three 12CM fans are installed on the top, the power supply can be installed in the level-2 hanging position.						
Note: The calculated length of the graphics card is the total length including the PCI-E bracket.						
Note: The length limit of the graphics card depends on the installation direction of the power supply.						
Note: If 360 AIO is installed under the top cover, it is recommended to use a power supply length of 14CM to obtain a longer graphics card installation space.						

Deutsch

AIO		PSU	≤14cm	≤15cm	≤16cm	≤18cm
240 / 280 AIO	Netzteil geeignet für	level-1	level-1	level-1	level-1	level-1
	Maximale Grafikkartenlänge	400mm	400mm	400mm	400mm	342~360mm
360 AIO	Netzteil geeignet für	level-3 or 4	level-3	level-3	level-3	level-3
	Maximale Grafikkartenlänge	342~360mm	342~360mm	342~360mm	342~360mm	335mm
Wenn die Länge der Grafikkarte kleiner oder gleich 330 mm ist, kann das Netzteil in der Level-4-Hängeposition installiert werden.						
Wenn drei 12-CM-Lüfter oben installiert sind, kann das Netzteil in der Hängeposition der Ebene 2 installiert werden.						
Hinweis: Die berechnete Länge der Grafikkarte ist die Gesamtlänge inklusive PCI-E-Bracket.						
Hinweis: Die Längenbegrenzung der Grafikkarte hängt von der Einbaurichtung des Netzteils ab.						
Hinweis: Wenn 360 AIO unter der oberen Abdeckung installiert ist, wird empfohlen, eine Netzteilänge von 14 cm zu verwenden, um einen längeren Installationsraum für die Grafikkarte zu erhalten.						

PSU installation steps
 Installationsschritte für das Netzteil
 Étapes d'installation du bloc d'alimentation
 電源安裝步驟

Français

AIO		PSU	≤14cm	≤15cm	≤16cm	≤18cm
240 / 280 AIO	Alimentation adaptée au	Niveau-1	Niveau-1	Niveau-1	Niveau-1	Niveau-1
	Limite de longueur de la carte graphique	400mm	400mm	400mm	400mm	342~360mm
360 AIO	Alimentation adaptée au	Niveau-3 ou 4	Niveau-3	Niveau-3	Niveau-3	Niveau-3
	Limite de longueur de la carte graphique	342~360mm	342~360mm	342~360mm	342~360mm	335mm
Lorsque la longueur de la carte graphique est inférieure ou égale à 330 mm, l'alimentation peut être installée en position suspendue de niveau 4.						
Lorsque trois ventilateurs de 12 cm sont installés sur le dessus, l'alimentation peut être installée en position suspendue de niveau 2.						
Remarque : La longueur calculée de la carte graphique est la longueur totale, y compris le support PCI-E.						
Remarque : La limite de longueur de la carte graphique dépend du sens d'installation de l'alimentation.						
Remarque : Si 360 AIO est installé sous le capot supérieur, il est recommandé d'utiliser une longueur d'alimentation de 14 cm pour obtenir un espace d'installation de carte graphique plus long.						

中文

水冷		電源	≤14cm	≤15cm	≤16cm	≤18cm
240 / 280 AIO	電源適合等級	level-1	level-1	level-1	level-1	level-1
	顯卡限長	400mm	400mm	400mm	400mm	342~360mm
360 AIO	電源適合等級	level-3 or 4	level-3	level-3	level-3	level-3
	顯卡限長	342~360mm	342~360mm	342~360mm	342~360mm	335mm
當顯卡長度≤330mm時，可將電源安裝於第4級掛位。						
當頂部安裝3個12CM風扇時，可將電源安裝於第2級掛位。						
注意：顯卡計算長度為包含PCI-E擴片的總長度。						
注意：顯卡長度取決於電源安裝方向。						
注意：頂部如果安裝360AIO，則建議搭配電源長度為14CM，可獲得較長的顯卡安裝空間。						

PSU installation steps
Installationsschritte für das Netzteil
Étapes d'installation du bloc d'alimentation
電源安裝步驟

PSU installation / Netzteil-Installation / Installation du bloc d'alimentation / 電源安裝

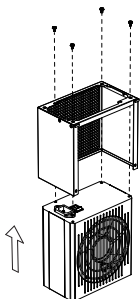

OR

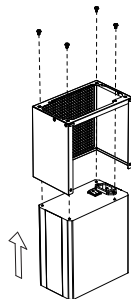

1-1

Note: The power plugs need to be inserted into the power supply first, and then installed on the front panel.

Hinweis: Die Netzstecker müssen zuerst in das Netzteil eingesteckt und dann an der Frontplatte installiert werden.

Remarque : Les fiches d'alimentation doivent d'abord être insérées dans le bloc d'alimentation, puis installées sur le panneau avant.

注意：電源插頭需先插入電源，再安裝到前板。

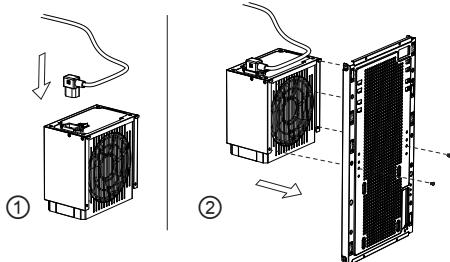
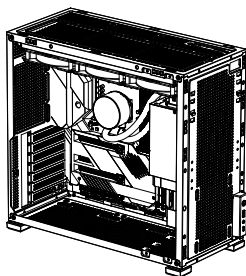

1-2

2.5" SSD / 3.5" HDD Installation
2,5-Zoll-SSD / 3,5-Zoll-HDD-Installation
Installation d'un SSD 2,5" / d'un disque dur 3,5"
2.5"SSD /3.5"HDD硬碟安裝

3.5" HDD Mounting Mode 1 / 3,5-Zoll-HDD-Montagemodus 1 /
Mode de montage du disque dur 3,5" 1 / 3.5" HDD安裝模式1

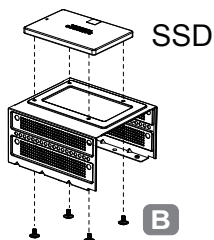

1-1

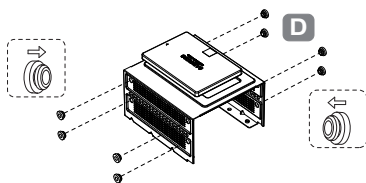

1-2

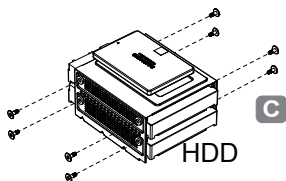

1-3

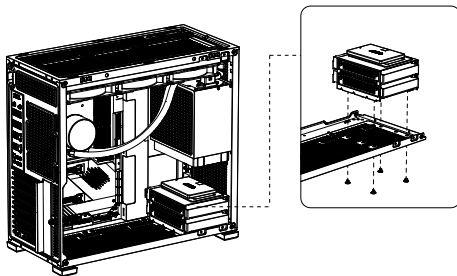
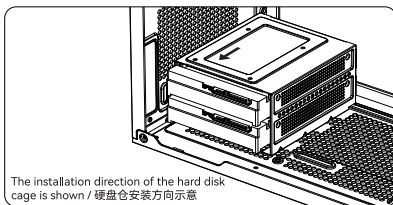

2.5" SSD / 3.5" HDD Installation
2,5-Zoll-SSD / 3,5-Zoll-HDD-Installation
Installation d'un SSD 2,5" / d'un disque dur 3,5"
2.5"SSD /3.5"HDD硬碟安裝

3.5" HDD Mounting Mode 2 / 3,5-Zoll-HDD-Montagemodus 2 /
Mode de montage du disque dur 3,5" 2 / 3.5" HDD 安裝模式 2

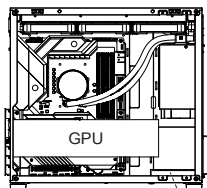
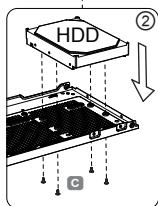
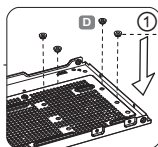
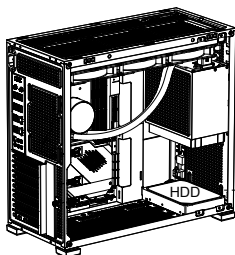

Remove the HDD cage /
Entfernen Sie den Festplattenkäfig /
Retirez la cage du disque dur /
移除硬盤盒



3.5"HDD*1

When the graphics card is installed in the second PCI-E slot of the chassis, the length of the graphics card length ≥ 309 mm, and the thickness ≥ 70 mm, it may be necessary to install 3.5"HDD x1 in this mode. /

Wenn die Grafikkarte im zweiten PCI-E-Steckplatz des Gehäuses installiert ist, die Länge der Grafikkarte ≥ 309 mm und die Dicke ≥ 70 mm beträgt, muss in diesem Modus möglicherweise eine 3,5-Zoll-HDD x1 installiert werden. /

Lorsque la carte graphique est installée dans le deuxième emplacement PCI-E du châssis, la longueur de la longueur de la carte graphique ≥ 309 mm et l'épaisseur ≥ 70 mm, il peut être nécessaire d'installer un disque dur 3,5" x1 dans ce mode. /

当显卡安装于机箱第二PCI-E插槽位，显卡长度 ≥ 309 mm，且厚度 ≥ 70 mm时，可能需按此模式进行安装3.5"HDD x1

2.5" SSD / 3.5" HDD Installation
2,5-Zoll-SSD / 3,5-Zoll-HDD-Installation
Installation d'un SSD 2,5" / d'un disque dur 3,5"
2.5"SSD /3.5"HDD硬碟安裝

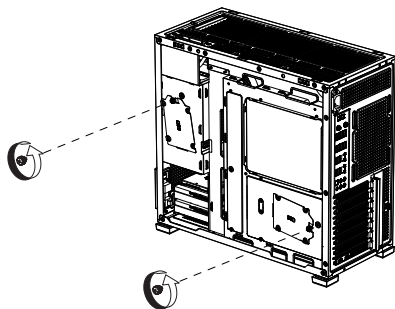

1-1

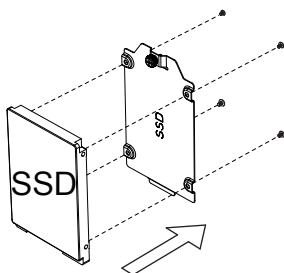

1-2

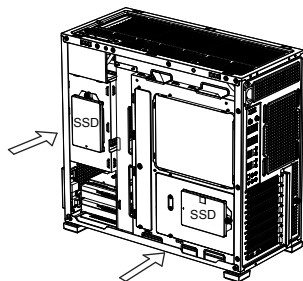

1-3

Cooling & Compatibility
Kühlung & Kompatibilität
Refroidissement et compatibilité
散熱兼容性說明

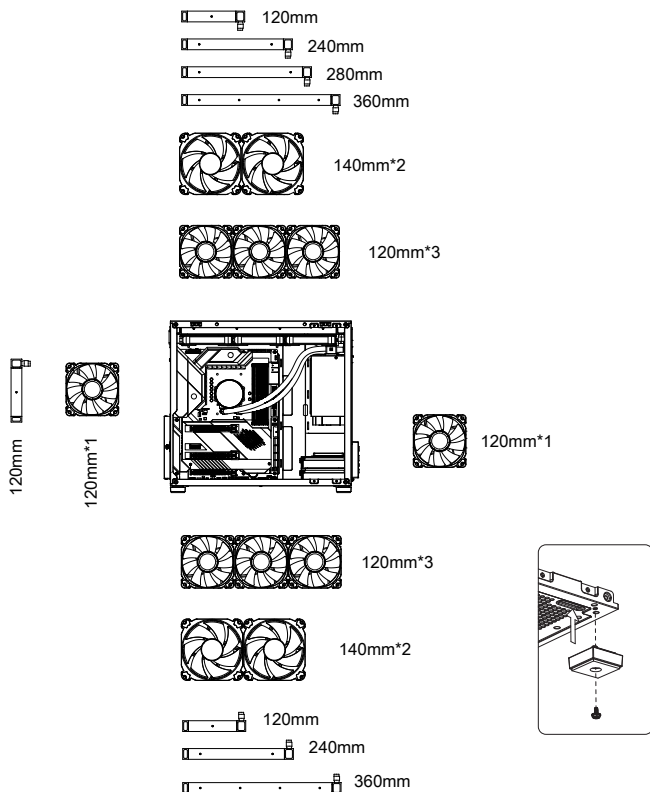

*Before installing the fan, it is recommended to route the cables at the back of the MB tray and connect it with the motherboard, and then secure with the screws.

*Vor der Installation des Lüfters wird empfohlen, die Kabel an der Rückseite des MB-Einschubs zu verlegen und mit dem Motherboard zu verbinden und dann mit den Schrauben zu befestigen.

*Avant d'installer le ventilateur, il est recommandé d'acheminer les câbles à l'arrière du plateau MB et de le connecter à la carte mère, puis de le fixer avec les vis.

*安裝風扇前，建議先走背線並與主機板連接後，再鎖螺絲。

Graphics card Installation Steps
Installationsschritte für Grafikkarten
Étapes d'installation de la carte graphique
顯卡安裝步驟

Graphics card installation/Installation Grafikkarte /Installer la carte graphique/安裝顯卡

Before installing the graphics card, it is recommended to plug the USB, switch and other related cables to the motherboard /

Vor der Installation der Grafikkarte wird empfohlen, das USB-, Switch- und andere zugehörige Kabel an das Motherboard anzuschließen /

Avant d'installer la carte graphique, il est recommandé de brancher les câbles USB, commutateur et autres câbles connexes à la carte mère /

顯卡安裝前，建議先把USB，開關等相關線纜插到主機板上

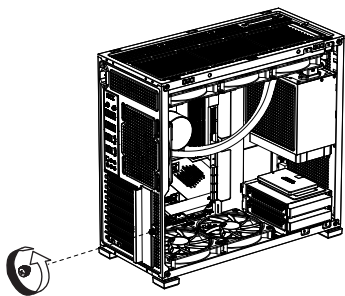

1-1

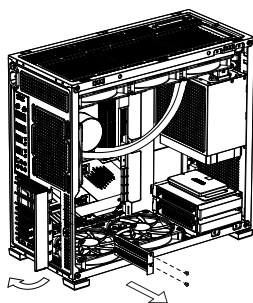

1-2

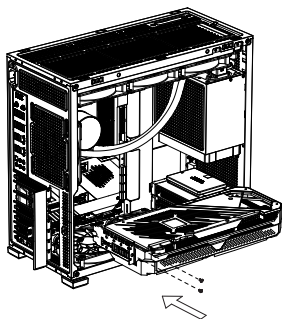

1-3

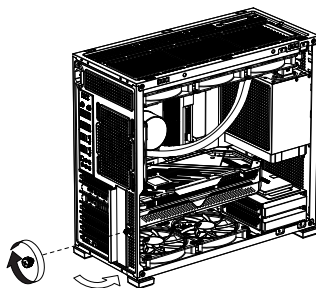

1-4

Finish Installation
Beenden Sie die Installation
Terminer l'installation
結束安裝

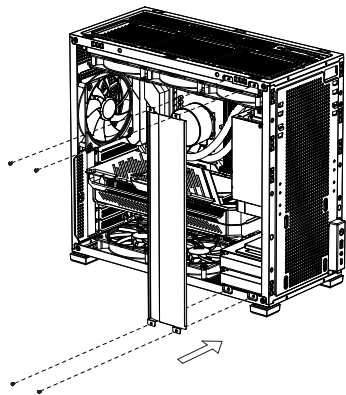

1-1

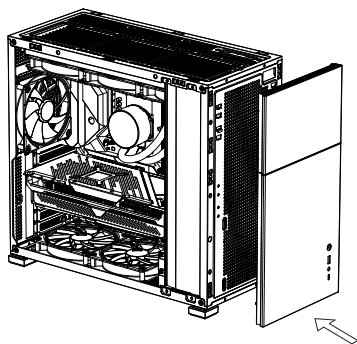

1-2

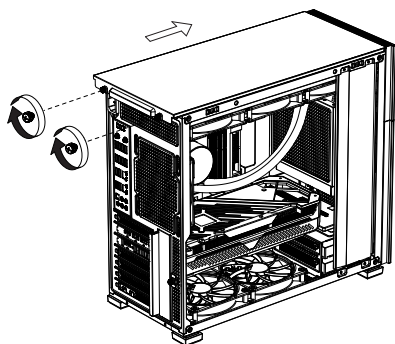

1-3

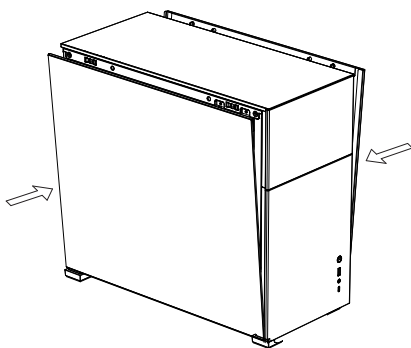

1-4

JONSBO

www.jonsbo.com